

ORGANIZATION AND STRENGTH OF THE PANZER REGIMENTS

10 MAY 1940

The information below is based on Thomas L. Jentz, *Panzertruppen: The Complete Guide to the Creation & Combat Employment Germany's Tank Force*, vol. 1 (Atglen, Pa.: Schiffer Military History, 1996). The German panzer formations were undergoing reorganization prior to launching the attack on France and the Low Countries. Each panzer battalion consists of two light companies and one medium company. Many of the companies retained the same organization and equipment used in the Polish Campaign the previous September. Others adopted an interim organization. A few had a full compliment of Panzer IIIs, IVs, 35ts, or 38ts. The strengths given below are for playing *Battlefront WWII*. Where there is no obvious command tank, choose one of the tanks in each company to be the command tank.

1st Panzer Division

Light Company

 x3 PzKpfw IIIE GE-74

 x3 PzKpfw IIC GE-71

 x3 PzKpfw IB GE-70

Medium Company

 x4 PzKpfw IVD GE-78

 x2 PzKpfw IIC GE-71

2nd Panzer Division

Light Company

 x3 PzKpfw IIIE GE-74

 x3 PzKpfw IIC GE-71

 x2 PzKpfw IB GE-70

Medium Company

 x3 PzKpfw IVD GE-78

 x3 PzKpfw IIC GE-71

3rd Panzer Division

Light Company

 x1 KIPzBefWg I GE-69

 x6 PzKpfw IIC GE-71

 x3 PzKpfw IB GE-70

Medium Company

 x1 KIPzBefWg I GE-69

 x3 PzKpfw IIIE GE-74

 x2 PzKpfw IVD GE-78

 x3 PzKpfw IB GE-70

4th Panzer Division

Light Company

 x1 KIPzBefWg I GE-69

 x6 PzKpfw IIC GE-71

 x3 PzKpfw IB GE-70

Medium Company

 x1 KIPzBefWg I GE-69

 x3 PzKpfw IIIE GE-74

 x2 PzKpfw IVD GE-78

 x3 PzKpfw IB GE-70

5th Panzer Division Panzer Regiment 15

Light Company

 x1 KIPzBefWg I GE-69

 x2 PzKpfw IIIE GE-74

 x3 PzKpfw IIC GE-71

 x3 PzKpfw IB GE-70

Medium Company

 x1 KIPzBefWg I GE-69

 x3 PzKpfw IVD GE-78

 x3 PzKpfw IIC GE-71

 x2 PzKpfw IB GE-70

5th Panzer Division Panzer Regiment 31

Light Company

 x1 KIPzBefWg I GE-69

 x3 PzKpfw IIIE GE-74

 x3 PzKpfw IIC GE-71

 x3 PzKpfw IB GE-70

Medium Company

 x1 KIPzBefWg I GE-69

 x3 PzKpfw IVD GE-78

 x3 PzKpfw IIC GE-71

 x2 PzKpfw IB GE-70

6th Panzer Division

Light Company

 x7 PzKpfw 35t GE-81

 x2 PzKpfw IIC GE-71

Medium Company

 x4 PzKpfw IVD GE-78

 x2 PzKpfw IIC GE-71

7th Panzer Division

Light Company

 x5 PzKpfw 38t GE-82

 x2 PzKpfw IIC GE-71

 x2 PzKpfw IB GE-70

Medium Company

 x3 PzKpfw IVD GE-78

 x3 PzKpfw IIC GE-71

ORGANIZATION AND STRENGTH OF THE PANZER REGIMENTS

10 MAY 1940 P.2

8th Panzer Division

Light Company

 x7 PzKpfw 38t GE-82

 x2 PzKpfw IIC GE-71

Medium Company

 x3 PzKpfw IVD GE-78

 x2 PzKpfw IIC GE-71

9th Panzer Division

1 Battalion, Panzer Regiment 33

Light Company

 x7 PzKpfw IIIE GE-74

 x2 PzKpfw IIC GE-71

Medium Company

 x4 PzKpfw IVD GE-78

 x2 PzKpfw IIC GE-71

9th Panzer Division

2 Battalion, Panzer Regiment 31

Light Company

 x1 KIPzBefWg I GE-69

 x6 PzKpfw IIC GE-71

 x3 PzKpfw IB GE-70

Medium Company

 x1 KIPzBefWg I GE-69

 x1 PzKpfw IIIC GE-73

 x2 PzKpfw IVD GE-78

 x3 PzKpfw IB GE-70

10th Panzer Division

Light Company

 x3 PzKpfw IIIE GE-74

 x3 PzKpfw IIC GE-71

 x2 PzKpfw IB GE-70

Medium Company

 x3 PzKpfw IVD GE-78

 x3 PzKpfw IIC GE-71

GE ME-03->ME-06, FS-01->FS-02

Maneuver Element-03 Infantry Company (Motorized)

Command		
HQ	x1 Commander	GE-46
Transport		
m	x1 Kubelwagen	GE-34
⊗	x9 Infantry	GE-44
⊗	x1 Heavy Machine Gun	GE-50
Organic Fire Support		
I	x1 5cm Mortar	GE-103
Transport		
m	x4 Medium Truck	GE-36

Maneuver Element-03 (alt) Infantry Company (Armored)

(1 per 1940 Pz Division)

Command		
HQ	x1 Commander	GE-46
Transport		
m	x1 Kubelwagen	GE-34
⊗	x9 Infantry	GE-44
⊗	x1 Heavy Machine Gun	GE-50
Organic Fire Support		
I	x1 5cm Mortar	GE-103
Transport		
m	x6 251/1 Halftrack	GE-21

Maneuver Element-04 Motorcycle Company

Command		
HQ	x1 Commander	GE-46
⊗	x9 Infantry	GE-44
⊗	x1 Heavy Machine Gun	GE-50
(x2 in the 7th Pz Div)		
Organic Fire Support		
I	x1 5cm Mortar	GE-103
Transport		
m	x12 Motorcycle	GE-94

Maneuver Element-05 Pioniere Company (Motorized)

Command		
HQ	x1 Commander	GE-46
Transport		
m	x1 Kubelwagen	GE-34
m	x9 Pioniere (x3 with Flm)	GE-47
Transport		
m	x3 Medium Truck	GE-36

Maneuver Element-06 Armored Car Company

⊗	x1 SdKfz 247 Armd Car	GE-P10
	or x1 SdKfz 263 [8 Rad] (a)	GE-93
⊗	Recon	
⊗	x2 Infantry	GE-44
Transport		
⊗	x2 Motorcycle	GE-94
⊗	x1 SdKfz 231 [8 Rad] AC(b)	GE-92
⊗	x1 SdKfz 232 [8 Rad] AC(c)	GE-P06
⊗	x4 SdKfz 221	AC(b) GE-90
⊗	x2 SdKfz 222	AC(b) GE-91

- (a) May replace with: SdKfz 263 [6 Rad]GE-P11
 (b) May replace with: SdKfz 231 [6 Rad]GE-P08
 (c) May replace with: SdKfz 232 [6 Rad]GE-P06

Fire Support Element-01 Light Howitzer Battalion

On-Board Attachment		
▲	x1 Forward Observer (a)	GE-48
Off-Board General Fire Support		
1st Light Howitzer Battery		
x2	105mm Field Guns (b)	
Off-Board General Fire Support		
2nd Light Howitzer Battery		
x2	105mm Field Guns (b)	
Off-Board General Fire Support		
3rd Light Howitzer Battery		
x2	105mm Field Guns (b)	

- (a) The forward observer may be attached to any maneuver element. Use the German Call for Fire table.
 (b) Large template. Indirect Fire weapon rating:
 -1 vs. V, 0 vs. T, G, sV

Fire Support Element-02 Heavy Howitzer Battalion

On-Board Attachment		
▲	x1 Forward Observer (a)	GE-48
Off-Board General Fire Support		
1st Heavy Howitzer Battery		
x2	150mm Field Guns (b)	
Off-Board General Fire Support		
2nd Heavy Howitzer Battery		
x2	150mm Field Guns (b)	
Off-Board General Fire Support		
3rd Heavy Howitzer Battery		
x2	105mm Field Guns (c)(d)	

- (a) The forward observer may be attached to any maneuver element. Use the German Call for Fire table.
 (b) Large template. Indirect Fire weapon rating:
 +1 vs. V, +2 vs. T, G, sV
 (c) Large template. Indirect Fire weapon rating:
 -1 vs. V, 0 vs. T, G, sV
 (d) x2 150mm Field Guns in 1st Pz Div.

GE FS-01->FS-05

Fire Support Element-03

Light Artillery Battalion

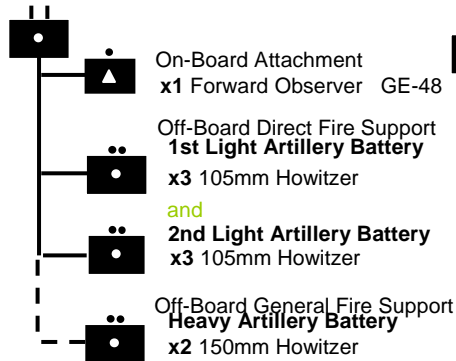

x2 Light Artillery Battery

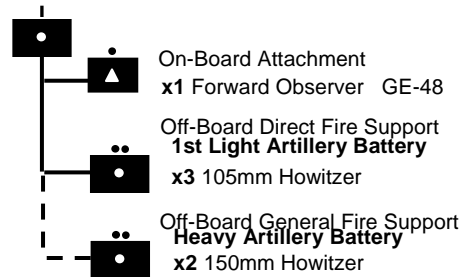

Fire Support Element-04

Light Artillery Battalion

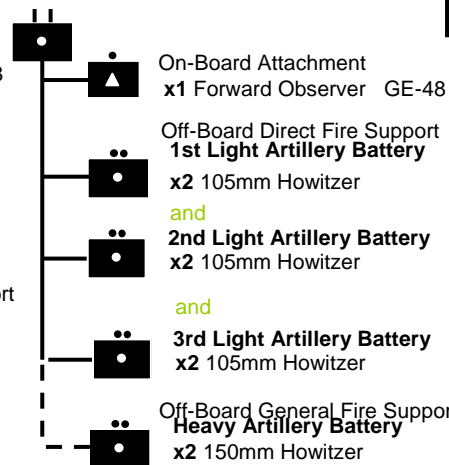

x3 Light Artillery Battery

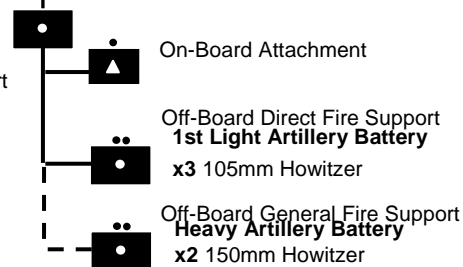

Fire Support Element-04

Light Artillery Battalion

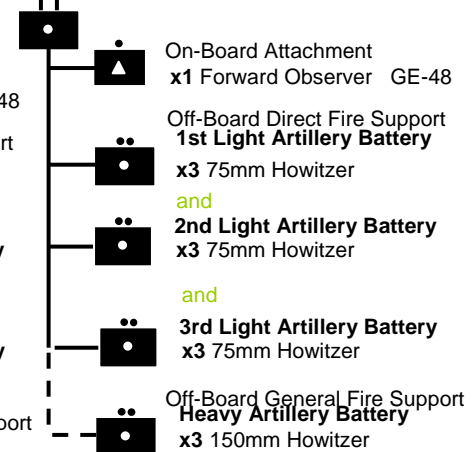

x3 Light Artillery Battery



GE BG-01->BG-03

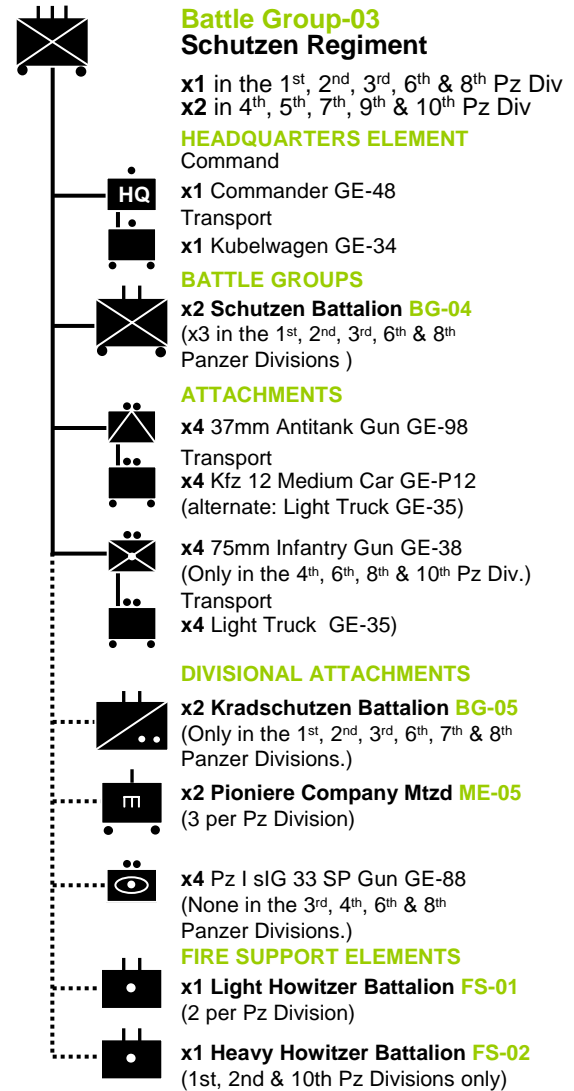
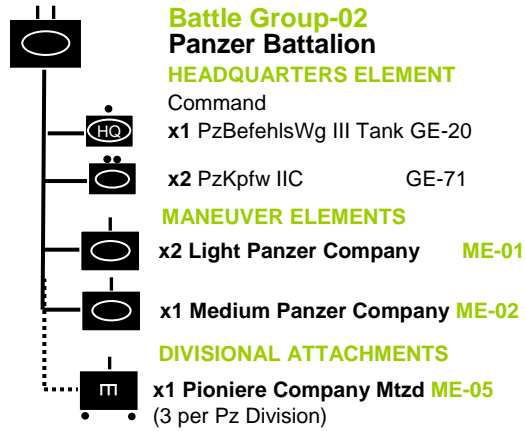
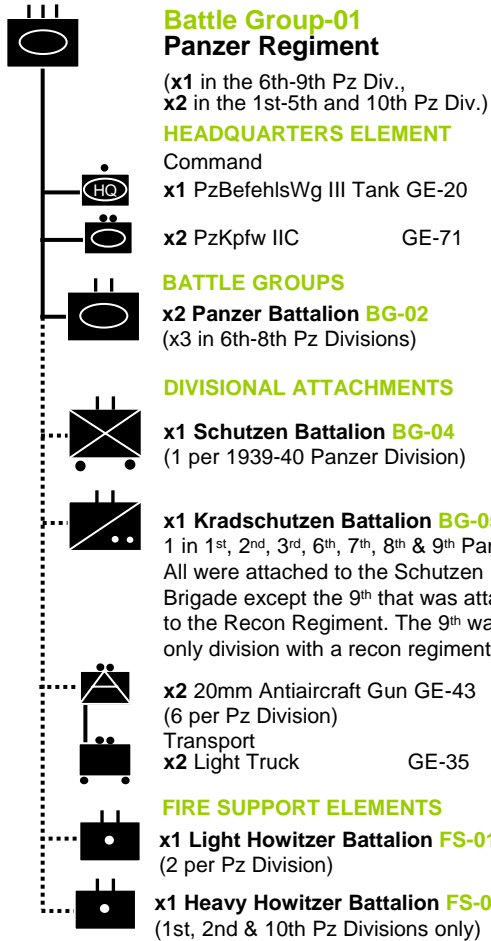

GE BG-04->BG-06

Battle Group-04 Schutzen Battalion

HEADQUARTERS ELEMENT

Command

x1 Commander GE-48

Transport

x1 Kubelwagen GE-34

MANEUVER ELEMENTS

x2 Infantry Company (Mtz) ME-03

(x3 in the 1st, 2nd, 3rd, 6th & 8th Panzer Divisions)

x2 Motorcycle Company ME-04

(None in the 6th & 8th Panzer Division)

ATTACHMENTS

x3 Pioniere (1 flame) GE-47

x3 Heavy Machine Gun GE-50

Organic Fire Support

x3 80mm Mortars GE-52

Transport

x5 Light Truck GE-35

x1 37mm Antitank Gun GE-98

(Not in the 10th Panzer Division.)

Transport

x1 Light Truck GE-35

x1 75mm Infantry Gun GE-38

(Not in the 6th, 8th & 10th Panzer Divisions.)

x2 in the 4th, 5th, 7th & 9th Panzer.)

Transport

x1 Light Truck GE-35

DIVISIONAL ATTACHMENTS

x3 37mm Antitank Gun GE-98

(18 per Panzer Division, except 12 in 6th, 7th & 8th Panzer.)

Transport

x3 Light Truck GE-35

x1 20mm Antiaircraft Gun GE-43

(6 per Panzer Division.)

Transport

x1 Light Truck GE-35

Battle Group-05 Kradshutzen Battalion

(Not in the 4th, 5th & 10th Panzer Divisions.)

HEADQUARTERS ELEMENT

Command

x1 Commander GE-48

Transport

x1 Kubelwagen GE-34

MANEUVER ELEMENTS

x3 Motorcycle Company ME-04

(x2 in the 1st, 3rd, 7th & 9th Panzer Divisions)

ATTACHMENTS

x3 Pioniere (1 flame) GE-47

Organic Fire Support

x3 80mm Mortars GE-52

Transport

x3 Light Truck GE-35

x1 37mm Antitank Gun GE-98

Transport

x1 Light Truck GE-35

x1 75mm Infantry Gun GE-38

(None in the 6th & 8th Pz Div)

Transport

x1 Light Truck GE-35

x3 Heavy Machine Gun GE-50

(Not in the 7th Panzer Division.)

Transport

x3 Motorcycle GE-94

DIVISIONAL ATTACHMENTS

x3 37mm Antitank Gun GE-98

(18 per Panzer Division, except 12 in 6th, 7th & 8th Panzer.)

Transport

x3 Light Truck GE-35

x1 20mm Antiaircraft Gun GE-43

(6 per Panzer Division.)

Transport

x1 Light Truck GE-35

Battle Group-06 Armored Reconnaissance Battalion

HEADQUARTERS ELEMENT

Command

x1 SdKfz 247 GE-P10

or SdKfz 263 [8 rad] GE-93

or SdKfz 263 [6 rad] GE-P11

MANEUVER ELEMENTS

x2 Armored Car Company ME-06

x1 Motorcycle Company ME-04

(Not in 9th Pz Div.)

ATTACHMENTS

x1 37mm Antitank Gun GE-98

(Not in the 7th or 9th Pz Div.)

Transport

x1 Light Truck GE-35

x1 75mm Infantry Gun GE-38

(None in the 9th, x2 in the 7th Pz Div.)

Transport

x1 Light Truck GE-35

x3 Pioniere (1 flame) GE-47

Transport

x1 Medium Truck GE-36

DIVISIONAL ATTACHMENTS

x2 Kradshutzen Battalion BG-05

(Only in the 9th Pz Division)

x1 20mm Antiaircraft Gun GE-43

(6 per Panzer Division.)

Transport

x1 Light Truck GE-35