

# BG-BRB01,02 1941 Panzer Division Battlegroups (1)

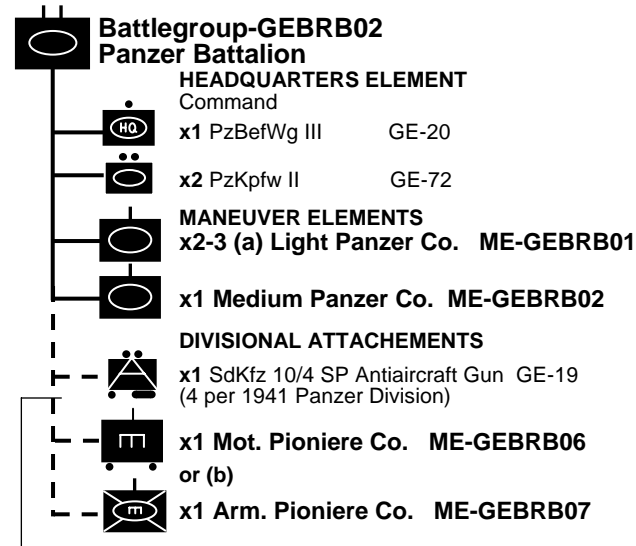
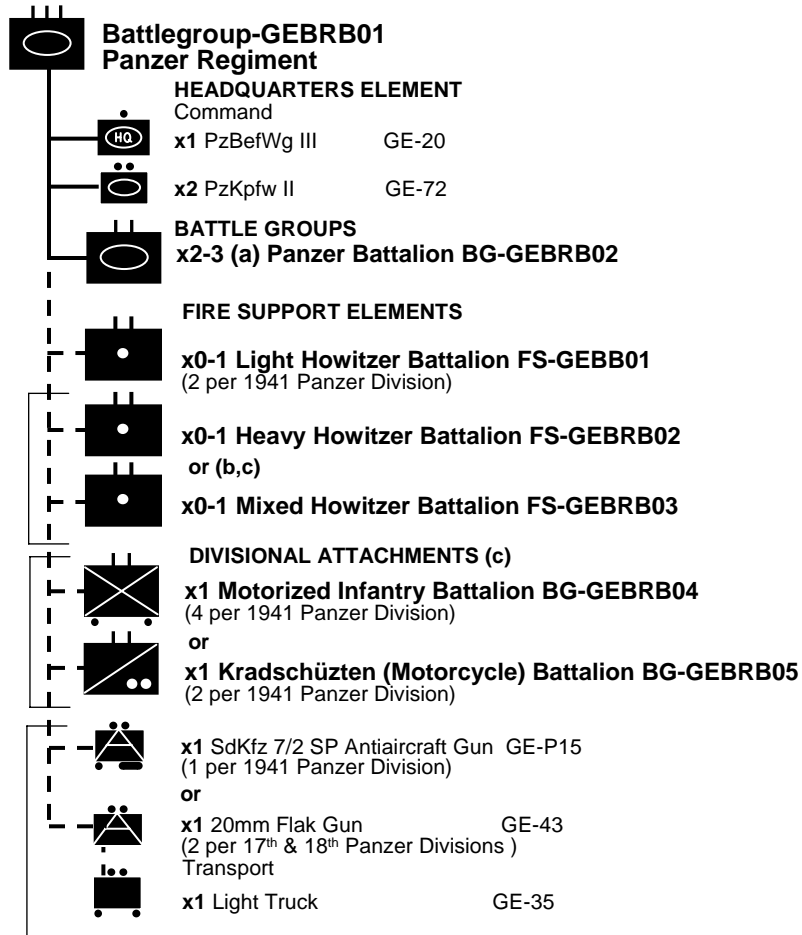

a) Most panzer battalions contain two light companies and one medium company. The battalions in 4<sup>th</sup>, 7<sup>th</sup>, and 10<sup>th</sup> panzer regiments had THREE light companies and one medium company.

b) The 1<sup>st</sup>, 3<sup>rd</sup>, 4<sup>th</sup>, 6<sup>th</sup>, 7<sup>th</sup>, 8<sup>th</sup>, 9<sup>th</sup>, 10<sup>th</sup>, 17<sup>th</sup>, 18<sup>th</sup>, 19<sup>th</sup> & 20<sup>th</sup> Panzer Divisions had 2 Mot. Pioniere and 1 Arm. Pioniere companies. The 11<sup>th</sup>, 12<sup>th</sup>, 13<sup>th</sup> & 14<sup>th</sup> Panzer Divisions had 3 Mot. Pioniere companies and no Arm. Pioniere companies

(a)

x2 Panzer Battalion in 1<sup>st</sup>, 4<sup>th</sup>, 9<sup>th</sup>, 10<sup>th</sup>, 11<sup>th</sup>, 13<sup>th</sup>, 14<sup>th</sup>, 16<sup>th</sup> Panzer Divisions

x3 Panzer Battalion in 3<sup>rd</sup>, 6<sup>th</sup>, 7<sup>th</sup>, 8<sup>th</sup>, 12<sup>th</sup>, 17<sup>th</sup>, 18<sup>th</sup>, 19<sup>th</sup>, and 20<sup>th</sup> Panzer Divisions

(b)

FS-BRB02 in 1<sup>st</sup>, 6<sup>th</sup>, 8<sup>th</sup>, 9<sup>th</sup>, 12<sup>th</sup>, 13<sup>th</sup>, 16<sup>th</sup>, 17<sup>th</sup>, 18<sup>th</sup>, 19<sup>th</sup>, & 20<sup>th</sup> Panzer Divisions

FS-BRG03 in 2<sup>nd</sup>, 3<sup>rd</sup>, 4<sup>th</sup>, 7<sup>th</sup>, 10<sup>th</sup>, 11<sup>th</sup>, & 14<sup>th</sup> Panzer Divisions

(c) The basic structure of the Panzer Division contained 1 Panzer regiment and 2 motorized infantry regiments (BG-GE BRB03). The various Battalion subunits of these organizations could be cross-attached as needed. Note that the artillery support listed in BG-GE BRB03 are the same units listed here. Again, the support could be organized to fit the mission.

# BG-BRB03,04 1941 Panzer Division Battlegroups (2)

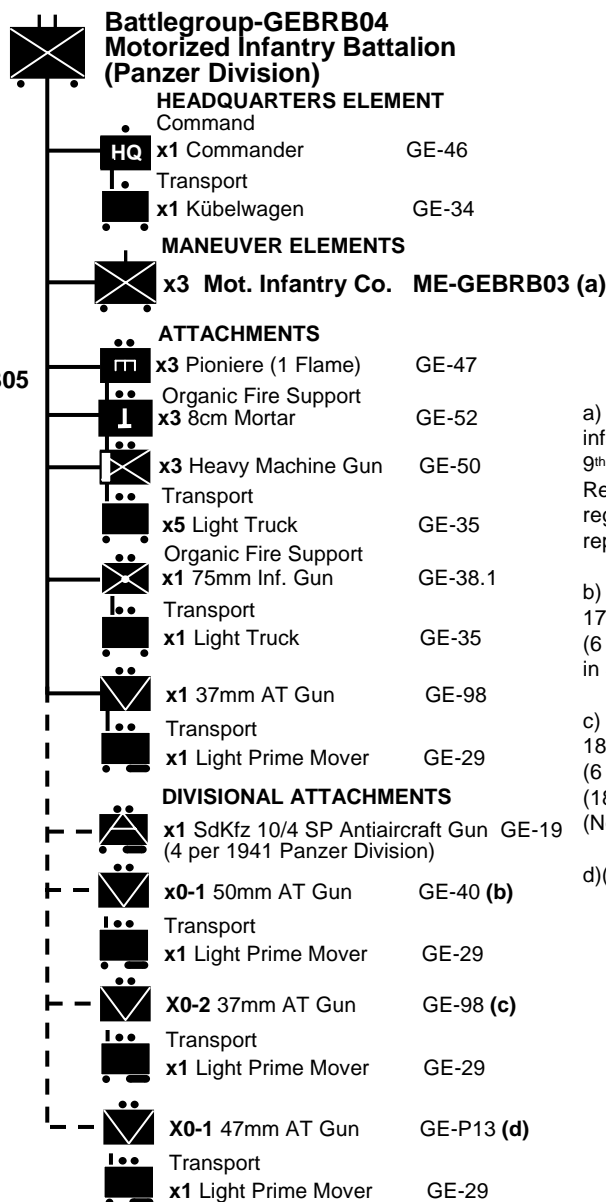
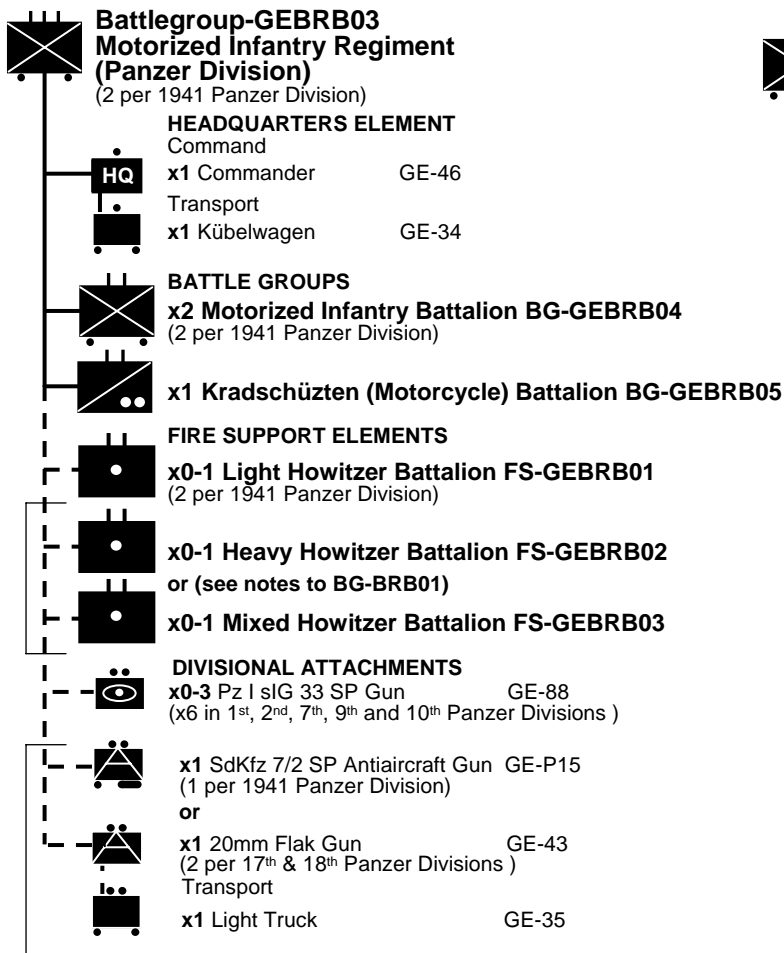

a) Replace one company with ME-BRB05, armored infantry company, per division in 3<sup>rd</sup>, 4<sup>th</sup>, 6<sup>th</sup>, 7<sup>th</sup>, 8<sup>th</sup>, 9<sup>th</sup>, 11<sup>th</sup>, 12<sup>th</sup>, 13<sup>th</sup>, 17<sup>th</sup>, 18<sup>th</sup> & 20<sup>th</sup> Panzer Divisions. Replace with one company with ME-BRB05 per regiment in 1<sup>st</sup> and 10<sup>th</sup> Panzer Divisions. No replacement in 14<sup>th</sup>, 16<sup>th</sup> & 19<sup>th</sup> Panzer Divisions.

b) (3 in 1<sup>st</sup>, 4<sup>th</sup>, 9<sup>th</sup>, 10<sup>th</sup>, 11<sup>th</sup>, 12<sup>th</sup>, 13<sup>th</sup>, 14<sup>th</sup>, 16<sup>th</sup>, 17<sup>th</sup>, & 18<sup>th</sup> Panzer Divisions)  
 (6 in 6<sup>th</sup>, 7<sup>th</sup>, 8<sup>th</sup>, 19<sup>th</sup> & 20<sup>th</sup>, Panzer Divisions) (None in 3<sup>rd</sup> Panzer Division)

c) (12 in 1<sup>st</sup>, 4<sup>th</sup>, 9<sup>th</sup>, 10<sup>th</sup>, 11<sup>th</sup>, 13<sup>th</sup>, 14<sup>th</sup>, 16<sup>th</sup>, 17<sup>th</sup>, & 18<sup>th</sup> Panzer Divisions)  
 (6 in 6<sup>th</sup>, 7<sup>th</sup>, 8<sup>th</sup>, 19<sup>th</sup> & 20<sup>th</sup>, Panzer Divisions)  
 (18 in 3<sup>rd</sup> Panzer Division)

d) (12 in 11<sup>th</sup> Panzer Division)

# BG-BRB05,06

## **Battlegroup-GEBRB05** **Kradschützen (Motorcycle) Battalion**

### HEADQUARTERS ELEMENT

Command

 **x1 Commander** GE-46

 **x1 Kübelwagen** GE-34

### MANEUVER ELEMENTS

 **x3 Motorcycle Co. ME-GEBRB04**



### ATTACHMENTS

 **x3 Pioniere (1 Flame)** GE-47

 **x3 Organic Fire Support**  
 **x3 8cm Mortar** GE-52

 **x3 Heavy Machine Gun** GE-50

 **x5 Light Truck** GE-35

 **x1 Organic Fire Support**  
 **x1 75mm Inf. Gun** GE-38.1

 **x1 Light Truck** GE-35

 **x1 37mm AT Gun** GE-98

 **x1 Light Prime Mover** GE-29

### DIVISIONAL ATTACHMENTS

 **x1 SdKfz 10/4 SP Antiaircraft Gun** GE-19  
(4 per 1941 Panzer Division)

 **x0-1 50mm AT Gun** GE-40 (a)

 **x1 Light Prime Mover** GE-29

 **X0-2 37mm AT Gun** GE-98 (b)

 **x1 Light Prime Mover** GE-29

 **X0-1 47mm AT Gun** GE-P13 (c)

 **x1 Light Prime Mover** GE-29

a) (3 in 1<sup>st</sup>, 4<sup>th</sup>, 9<sup>th</sup>, 10<sup>th</sup>, 11<sup>th</sup>, 12<sup>th</sup>, 13<sup>th</sup>, 14<sup>th</sup>, 16<sup>th</sup>, 17<sup>th</sup>, & 18<sup>th</sup> Panzer Divisions)  
(6 in 6<sup>th</sup>, 7<sup>th</sup>, 8<sup>th</sup>, 19<sup>th</sup> & 20<sup>th</sup>, Panzer Divisions) (None in 3<sup>rd</sup> Panzer Division)

b) (12 in 1<sup>st</sup>, 4<sup>th</sup>, 9<sup>th</sup>, 10<sup>th</sup>, 11<sup>th</sup>, 13<sup>th</sup>, 14<sup>th</sup>, 16<sup>th</sup>, 17<sup>th</sup>, & 18<sup>th</sup> Panzer Divisions)  
(6 in 6<sup>th</sup>, 7<sup>th</sup>, 8<sup>th</sup>, 19<sup>th</sup> & 20<sup>th</sup>, Panzer Divisions)  
(18 in 3<sup>rd</sup> Panzer Division)  
(None in 12<sup>th</sup> Panzer Division)

c)(12 in 11<sup>th</sup> Panzer Division)

## **Battlegroup-GEBRB06** **Armored Reconnaissance Battalion**

Command

 **x1 SdKfz 263 [8 Rad]** GE-93 (a)

### MANEUVER ELEMENTS

 **x1 Arm. Car Co. ME- GEBRB08**

 **x1 Motorcycle Co. ME-GEBRB04**

### ATTACHMENTS

 **x2 Pioniere** GE-47

 **x1 Medium Truck** GE-36

 **x1 Organic Fire Support**  
 **x1 75mm Inf. Gun** GE-38.1

 **x1 Light Truck** GE-35

 **x1 37mm AT Gun** GE-98

 **x1 Light Truck** GE-35

### DIVISIONAL ATTACHMENTS

 **x1 SdKfz 10/4 SP Antiaircraft Gun** GE-19  
(4 per 1941 Panzer Division)

(a) Replace in 7<sup>th</sup> & 20<sup>th</sup> Panzer Divisions with French AMD Panhard 178, 25mm Arm. Car, FR-15

# BG-BRB07,08,09 1941 Motorized Rifle Division Battlegroups

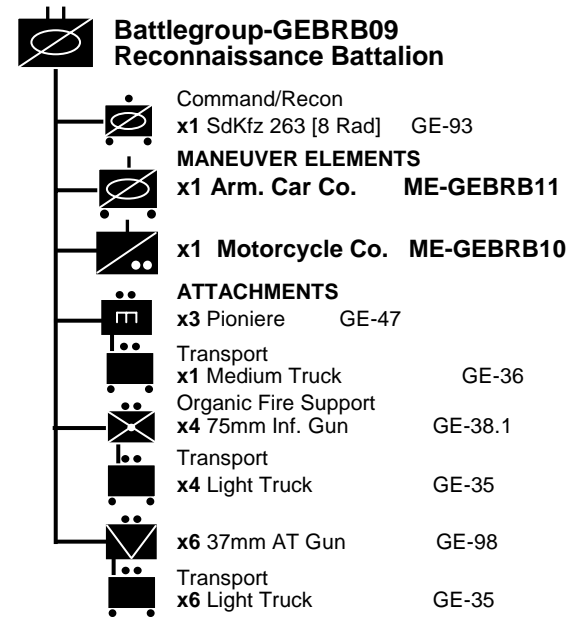
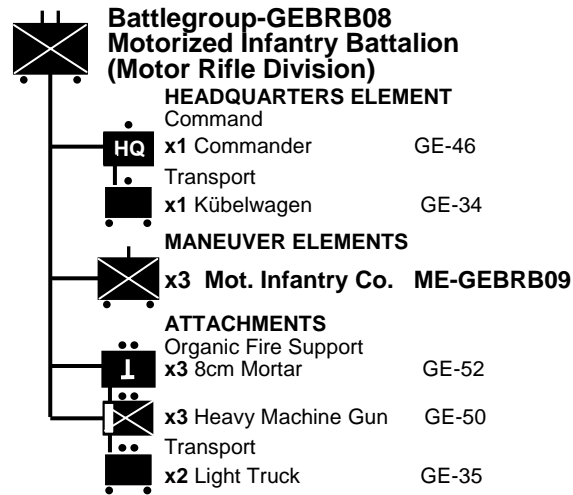
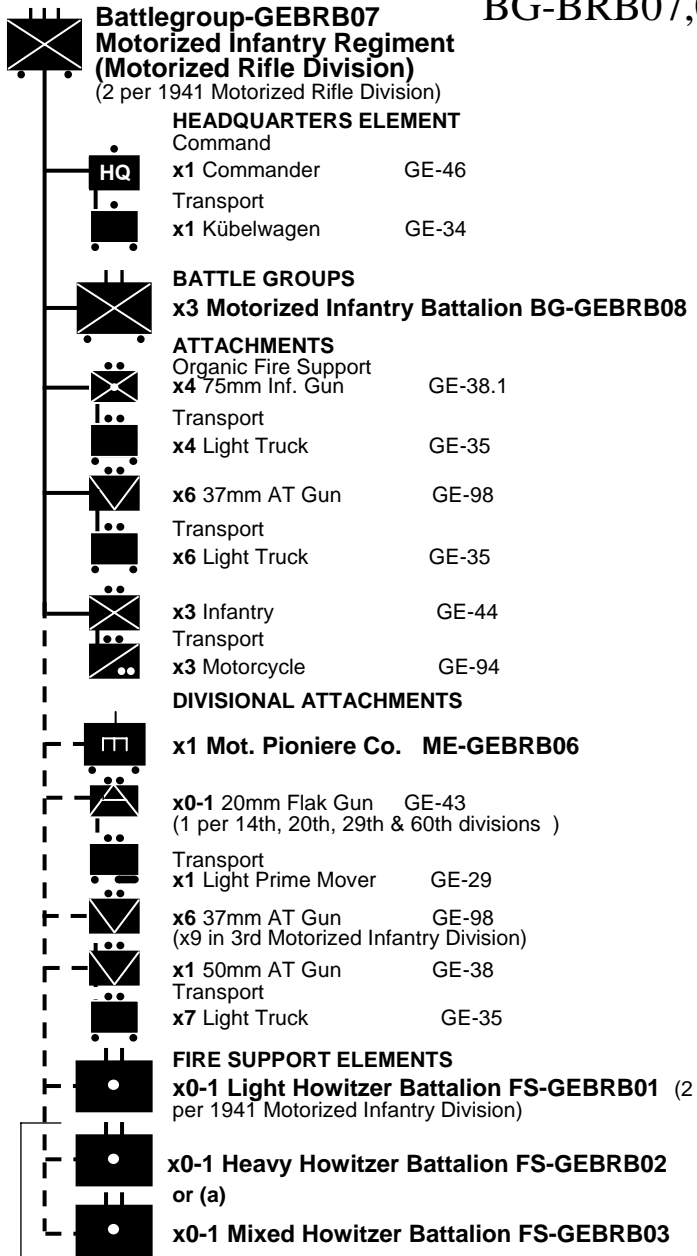

(a) Use Mixed Howitzer Battalion in 3rd, 14th, 16th, 18th, 20th, and 60th Motorized Infantry Divisions.

# 1941 Panzer Division Maneuver Elements

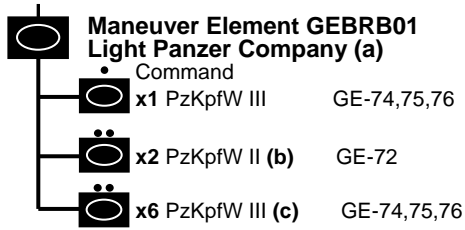

a) The official establishment. See the accompanying list for actual strengths and types in each Panzer unit in June 1941

b) Light platoon.

c) Organized as 3 platoons

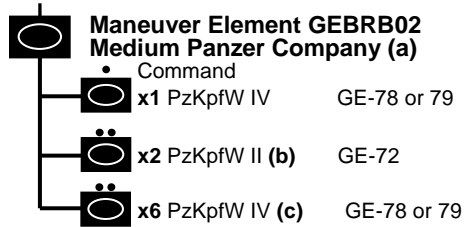

a) The official establishment. See the accompanying list for actual strengths and types in each Panzer unit in June 1941

b) The light platoon.

c) Organized as 3 platoons

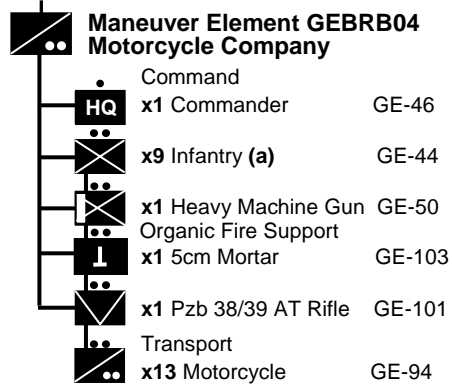
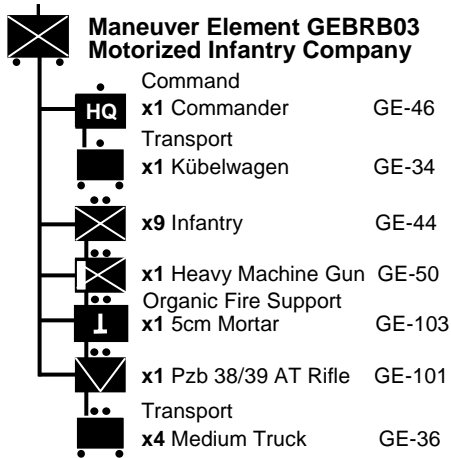

(a) May replace up to 6 with LMG GE-49

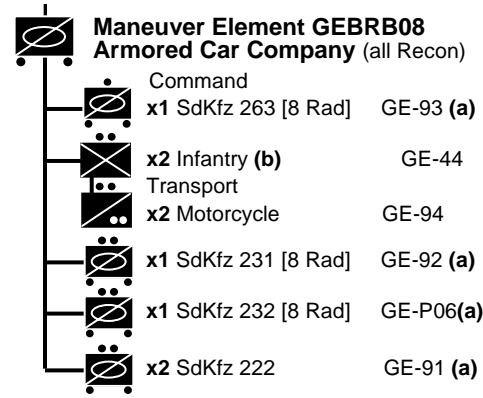
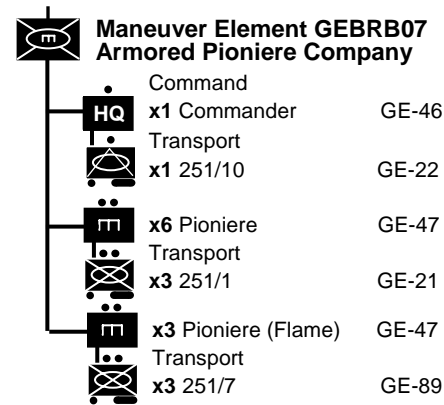
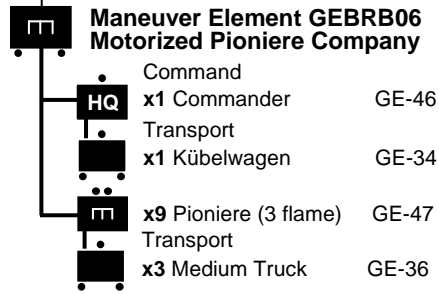
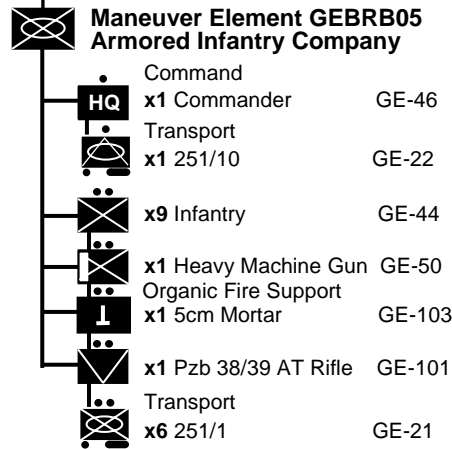

(a) Replace in 7<sup>th</sup> & 20<sup>th</sup> Panzer Divisions with French AMD Panhard 178, 25mm Arm. Car, FR-15

(b) May replace with LMG GE-49

# 1941 Motorized Rifle Division Maneuver Elements

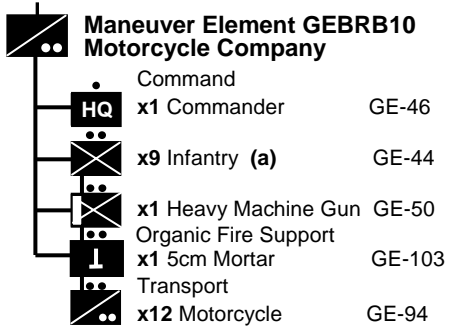
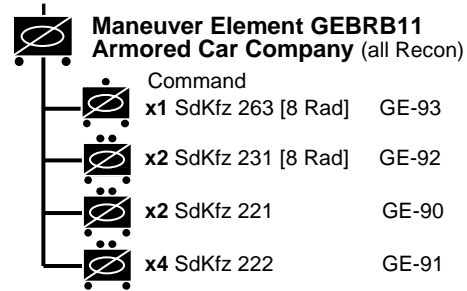
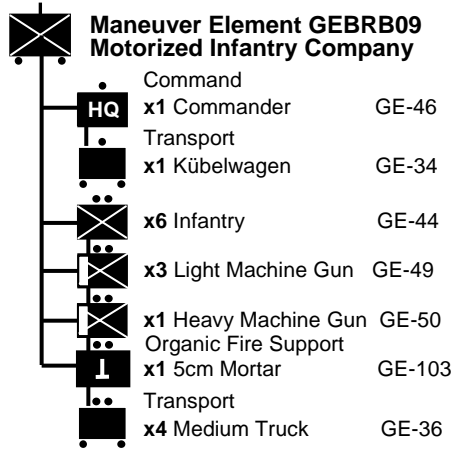

(a) May replace up to 6 with LMG GE-49

# GE Barbarossa Fire Support

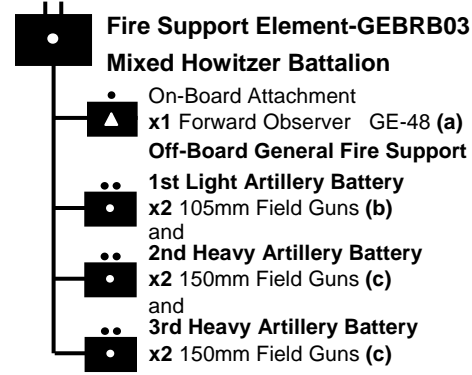
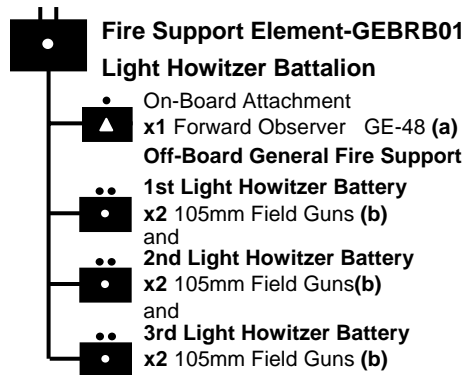

- a) May be attached to any on-board element
- b) Indirect Fire Weapon Rating: -1 vs V, 0 vs T,G,sV, Lrg Template
- c) Indirect Fire Weapon Rating: +1 vs V, +2 vs T,G,sV, Lrg Template