

GE ME-01->ME-03

Maneuver Element-01

Panzer Company (a)

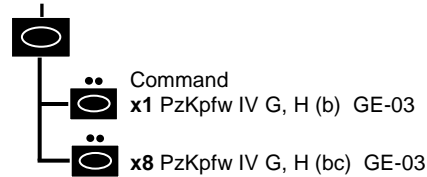

(a) May operate as x4 Panzer Platoon

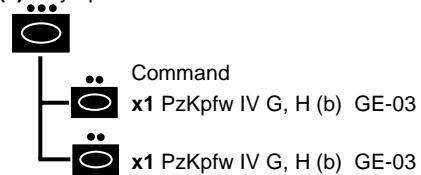

(b) Mid-late '43, one or two companies in a PzIV battalion might still be equipped with PzIII. Substitute all GE-03 with one type or a mix of PzIII L, M (GE-01) and PzIII N (GE-02)

Late '43 and Late '44 after summer offensives there were shortages of tanks. May Replace all tanks in a company with Stug III G (GE-13).

Mid-Late '43, some Pz battalions were re-equipped with PzV. Replace all tanks with PzV Panther GE-04

(c) Late'44, Pz companies were authorized alternative company strengths of x1 command and x6 or x3 tanks. Each reduced company can operate as platoon-sized ME of 2 tanks each.

Maneuver Element-02

Heavy Panzer Company (a)



(a) May operate as x3 Heavy Panzer Platoon:

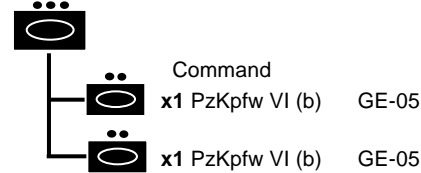

(b) Late '44 may replace PzVIE tanks in SS divisions with Konigstiger PzVIB GE-06

Maneuver Element-03

Assault Gun Company (a)

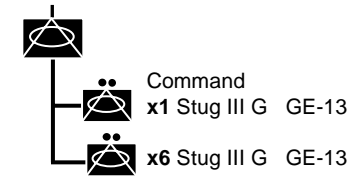

(a) May operate as x3 Assault Gun Platoon

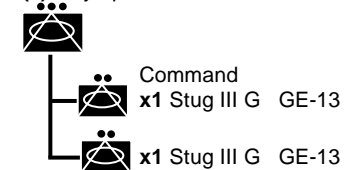

GE ME-04->ME-07

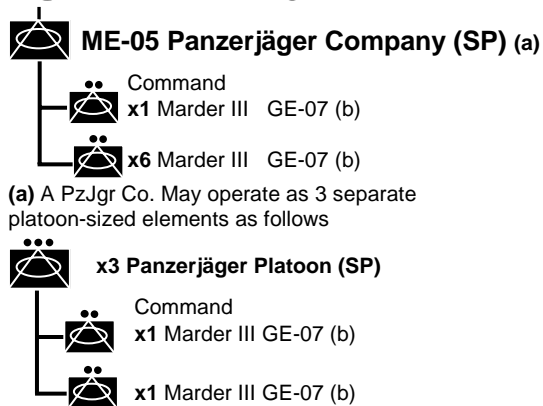
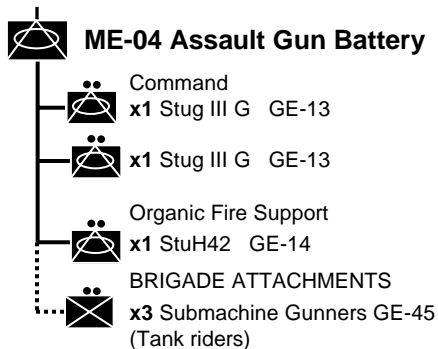

- (b) Early '43 may replace Marders with Stug IIIG GE-13
- Early '44 with Jadgpanzer IV with L48 Gun GE-10
 - Mid '44 with Jadgpanzer IV with L70 Gun GE-10.1
 - Mid '44 with Hetzer GE-08

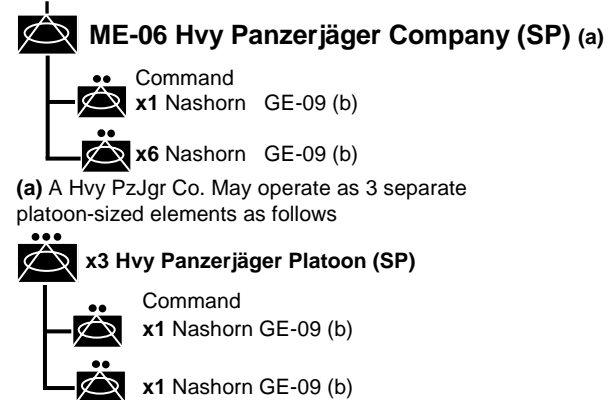

- (b) Mid '43 may replace Nashorn with Ferdinand/Elefant GE-12/GE-12.1
- Late '44 with Jadgpanther GE-11
 - Late '44 with JadgTiger GE-54

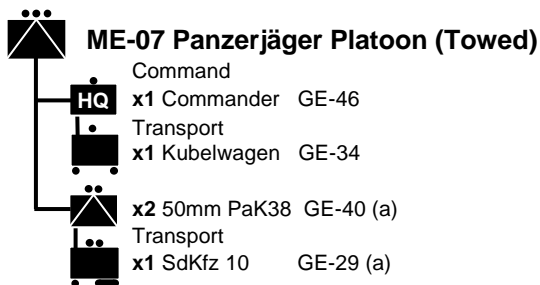

- (a) Early '44 may replace Pak38 GE-40/transport GE-29 with
- 75mm Pak 40 GE-41/SdKfz Medium Prime Mover GE-30
- Late'44 may replace with:
- 88mm Pak 43/41 GE-65.1/SdKfz Heavy Prime Mover GE-31

GE ME-08->ME-11

Maneuver Element-08

Panzergranadier Company (Mtz.)

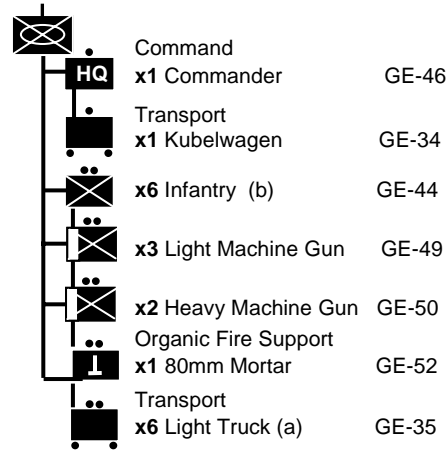

- (a) May substitute groups of 3 light trucks with x2 Medium Truck GE-36
- (b) Early '44, may arm up to ½ of infantry with Pzfaust. Late '44 ½ or more with Pzfaust.

Maneuver Element-09

Panzergranadier Company (Armored)

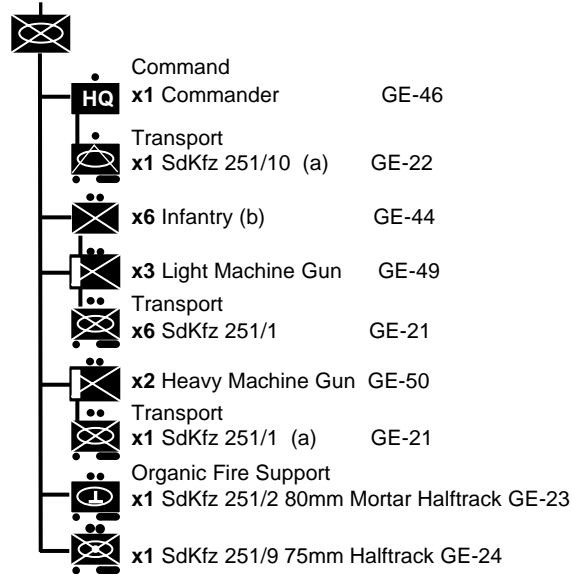

- (a) Mid '44, replace the halftracks transporting the commander and HMG with SdKfz 251/17 20mm AA halftrack. Allow it to transport 1 T
- (b) Early '44, may arm up to ½ of infantry with Pzfaust. Late '44 ½ or more with Pzfaust.

Maneuver Element-10

Infantry Company

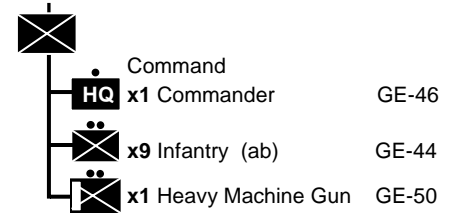

- (a) May replace 1-3 infantry with LMG GE-49 to reflect personnel shortages
- (b) Early '44, may arm up to ½ of infantry with Pzfaust. Late '44 ½ or more with Pzfaust.

Maneuver Element-11

Volksgrenadier Company

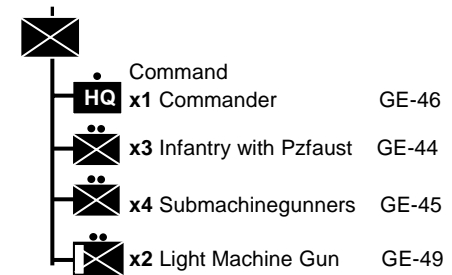

GE ME-12->ME-15

Maneuver Element-12

Flakpanzer Platoon

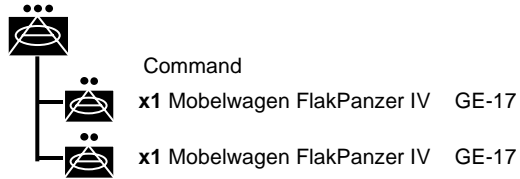

ATTACHMENTS

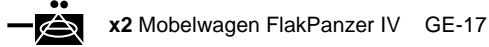

Maneuver Element-13

Light Flak Platoon (SP)



ATTACHMENTS

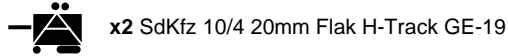

Maneuver Element-14

Light Flak Platoon (Towed)

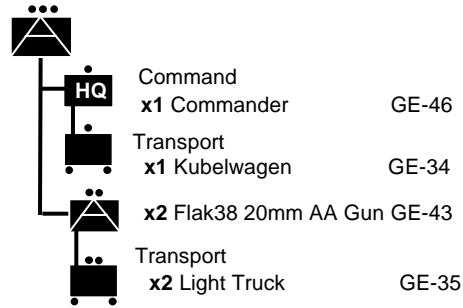

ATTACHMENTS

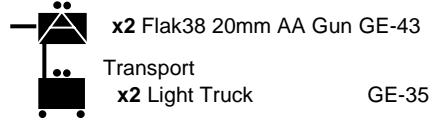

Maneuver Element-15

Heavy Flak Battery

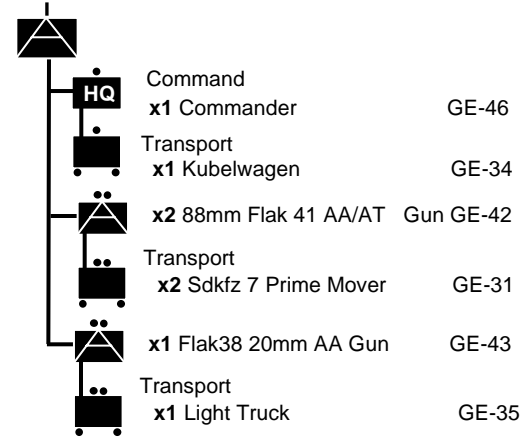

GE ME-16->ME-18

Maneuver Element-16

Pz. Engineer Company (Armored)

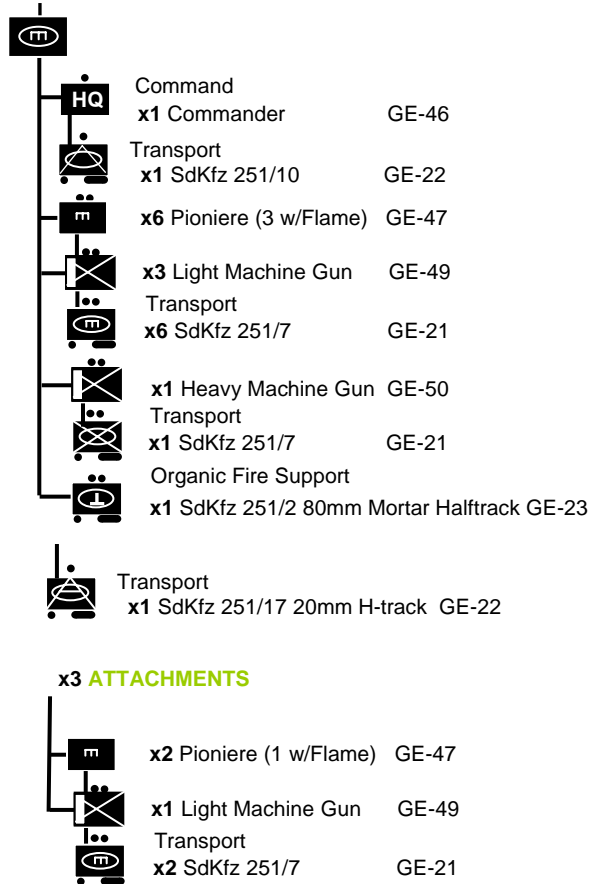

Maneuver Element-17

Pz. Engineer Company (Armored)

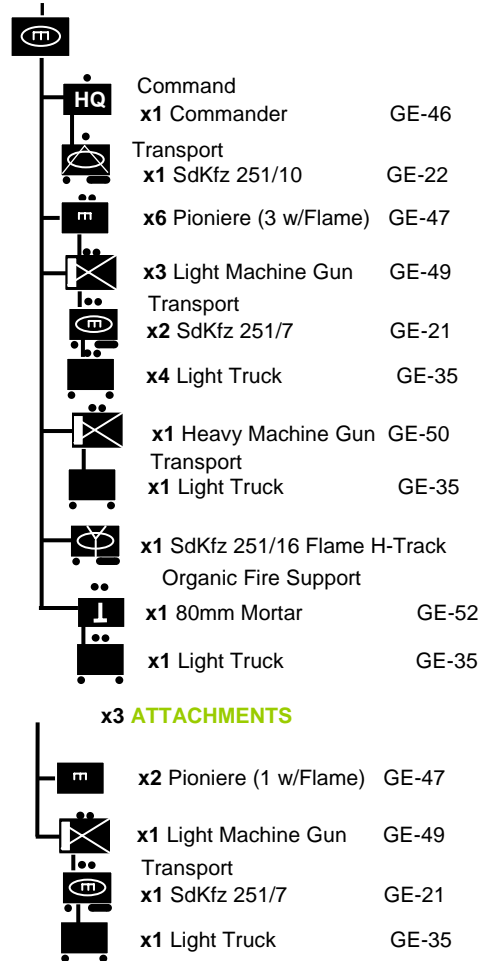

Maneuver Element-18

Engineer Company

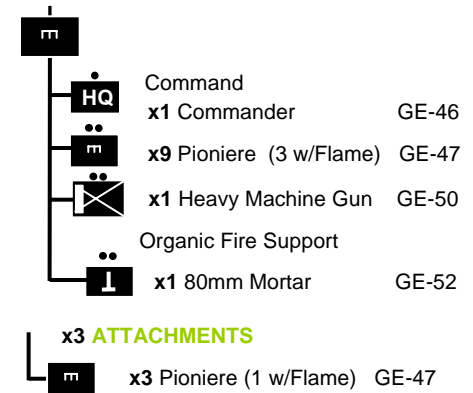

GE ME-19->ME-23

Maneuver Element-19

Pz. Engineer Company (Mtz)

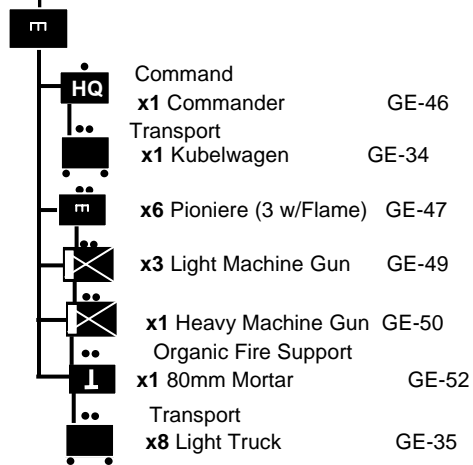

x3 ATTACHMENTS



Maneuver Element-20

Armored Car Platoon

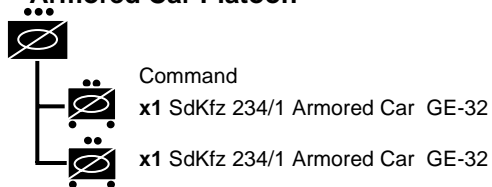

Maneuver Element-21

Armored Car Platoon (Halftrack)

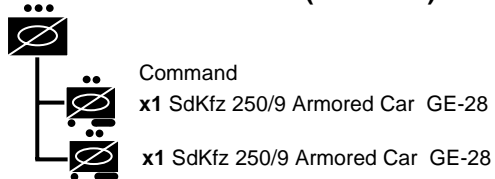

Maneuver Element-23

Pz. Reconnaissance Platoon

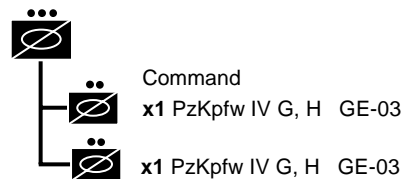

Maneuver Element-22

Light Armored Reconnaissance Company

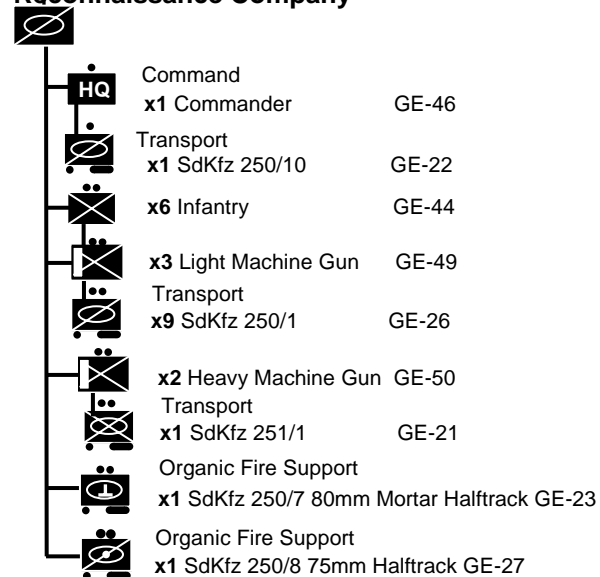

GE FS-01->FS-05

Fire Support Element-01

Heavy Mortar Platoon



x2 Heavy Mortar Section

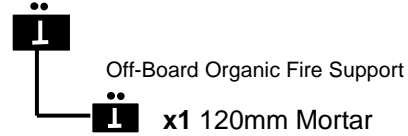

Fire Support Element-02

Mixed Artillery Battalion (SP)

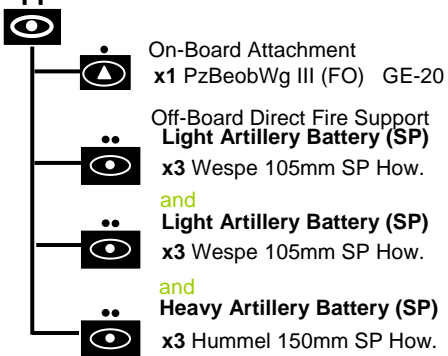

x2 Light Artillery Battery (SP)

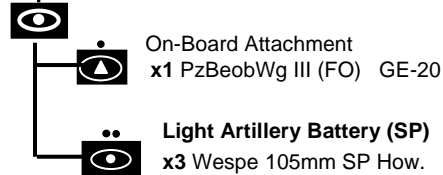

x1 Heavy Artillery Battery (SP)

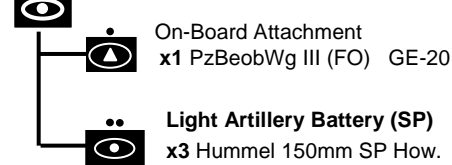

Fire Support Element-03

Light Artillery Battalion

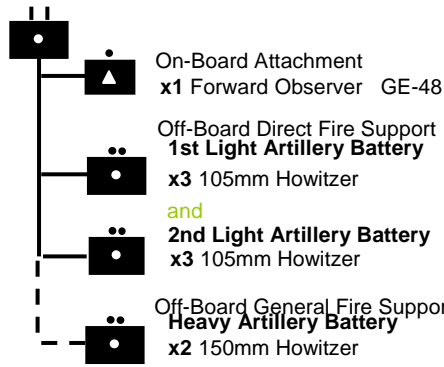

x2 Light Artillery Battery

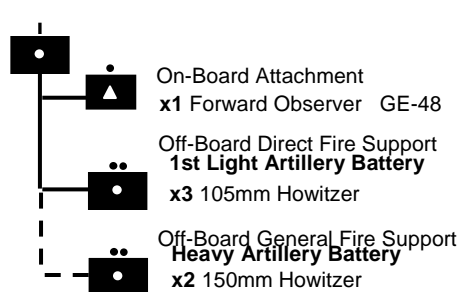

Fire Support Element-04

Light Artillery Battalion

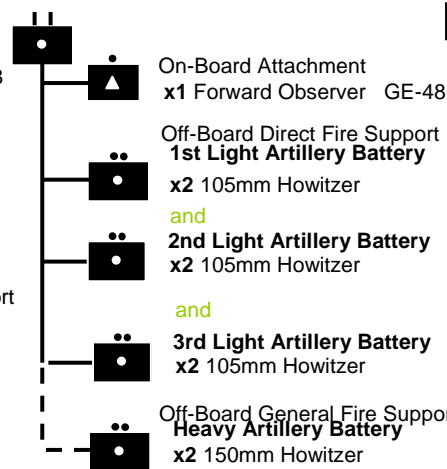

x3 Light Artillery Battery

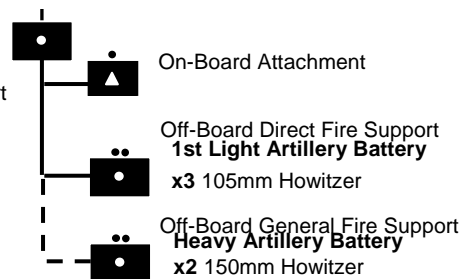

Fire Support Element-04

Light Artillery Battalion

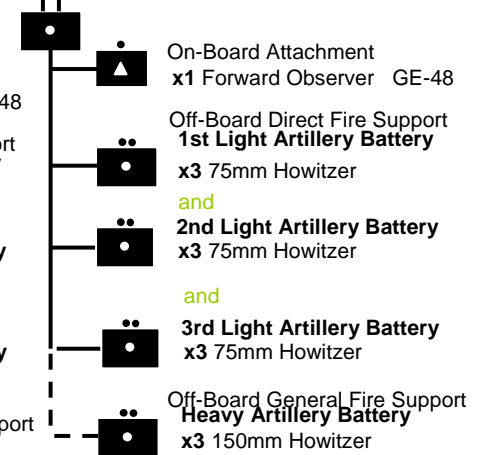

x3 Light Artillery Battery



GE BG-01->BG-02

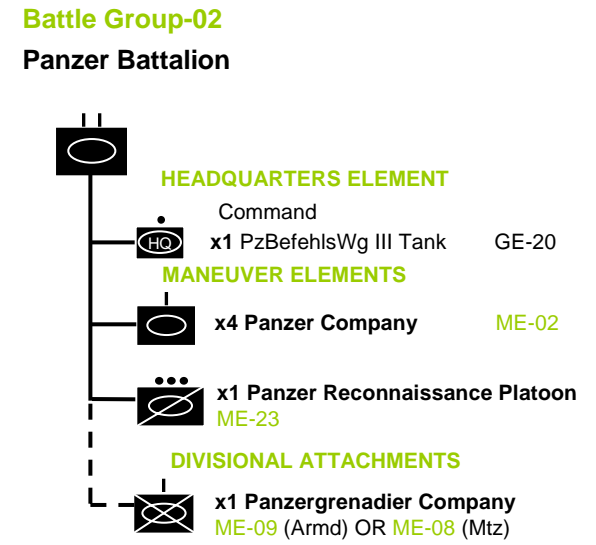
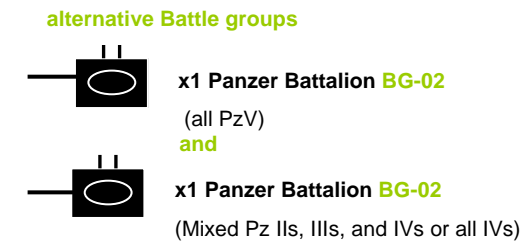
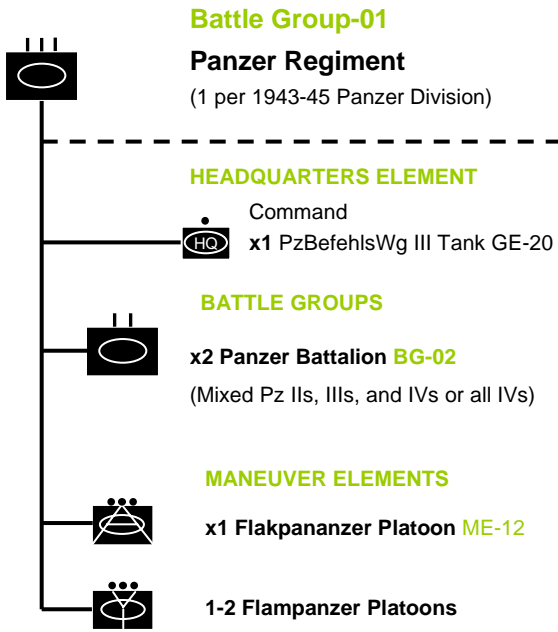



GE BE-03->BG-04

Battle Group-03



Panzergrenadier Regiment

(2 per 1943-45 Panzer Division)

HEADQUARTERS ELEMENT

-  Command
x1 Commander GE-46
-  Transport
x1 SdKfz 251/1 GE-21

BATTLE GROUPS

-  x1 Panzergrenadier Bn. (Armd) **BG-04**
- and
-  x1 Panzergrenadier Bn (Mtz) **BG-05**

MANEUVER ELEMENTS

-  x3 Light Flak Platoon (SP) **ME-13**

-  x1 Panzer Engineer Company (Armd) **ME-17**







Alternative Battle groups

-  x2 Panzergrenadier Bn. (Mtz) **BG-05**

Alternative Maneuver Element

-  x1 Panzer Engineer Company (Mtz) **ME-19**



DIVISIONAL ATTACHMENTS

-  x1 Panzer Battalion **BG-02**
(Mixed Pz IIs, IIIs, IVs or all Pz IVs)
-  x1 Panzerjaeger Company (SP) **ME-05**
-  x1 Panzerjaeger Platoon (Towed) **ME-07**
-  x1 Light Flak Platoon (Towed) **ME-14**
-  x1 Heavy Flak Battery **ME-15**
-  x1 Panzer Engineer Company (Armd) **ME-17**
-  x1 Mixed Artillery Battalion (SP) **FS-02**

NON-DIVISIONAL ATTACHMENT

-  x1 Heavy Panzer Company **ME-02**



Alternatives

-  x1 Panzer Engineer Company (Mtz) **ME-19**
-  x1 Light Artillery Battalion (Towed) **FS-03**

Battle Group-04

Panzergrenadier Battalion (Armored)

HEADQUARTERS ELEMENT

-  Command
x1 Commander GE-46
-  Transport
x1 SdKfz 251/1 GE-21

MANEUVER ELEMENTS

-  x3 Panzergrenadier Company (Armd) **ME-09**

ATTACHMENTS

- Organic Fire Support
-  x1 SdKfz 251/9 75mm GE-24

FIRE SUPPORT ELEMENT

- Off-board Organic Fire Support
-  x1 Heavy Mortar Platoon **FS-01**

DIVISIONAL ATTACHMENTS

-  x1 Panzer Company **ME-01**
(from a Panzer Battalion)

Battle Group-05

Panzergranadier Battalion (Motorized)

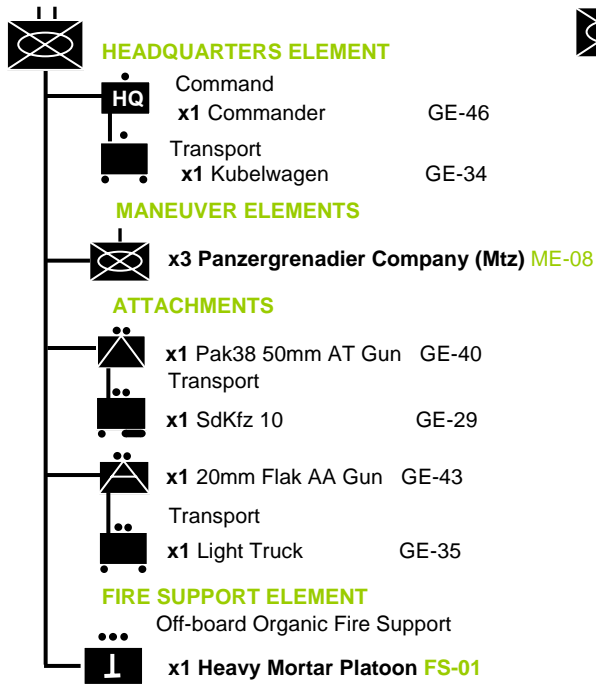

GE BG-05->BG-06

Battle Group-06

Panzergranadier Regiment

(2 per 1943-45 Panzer Division)

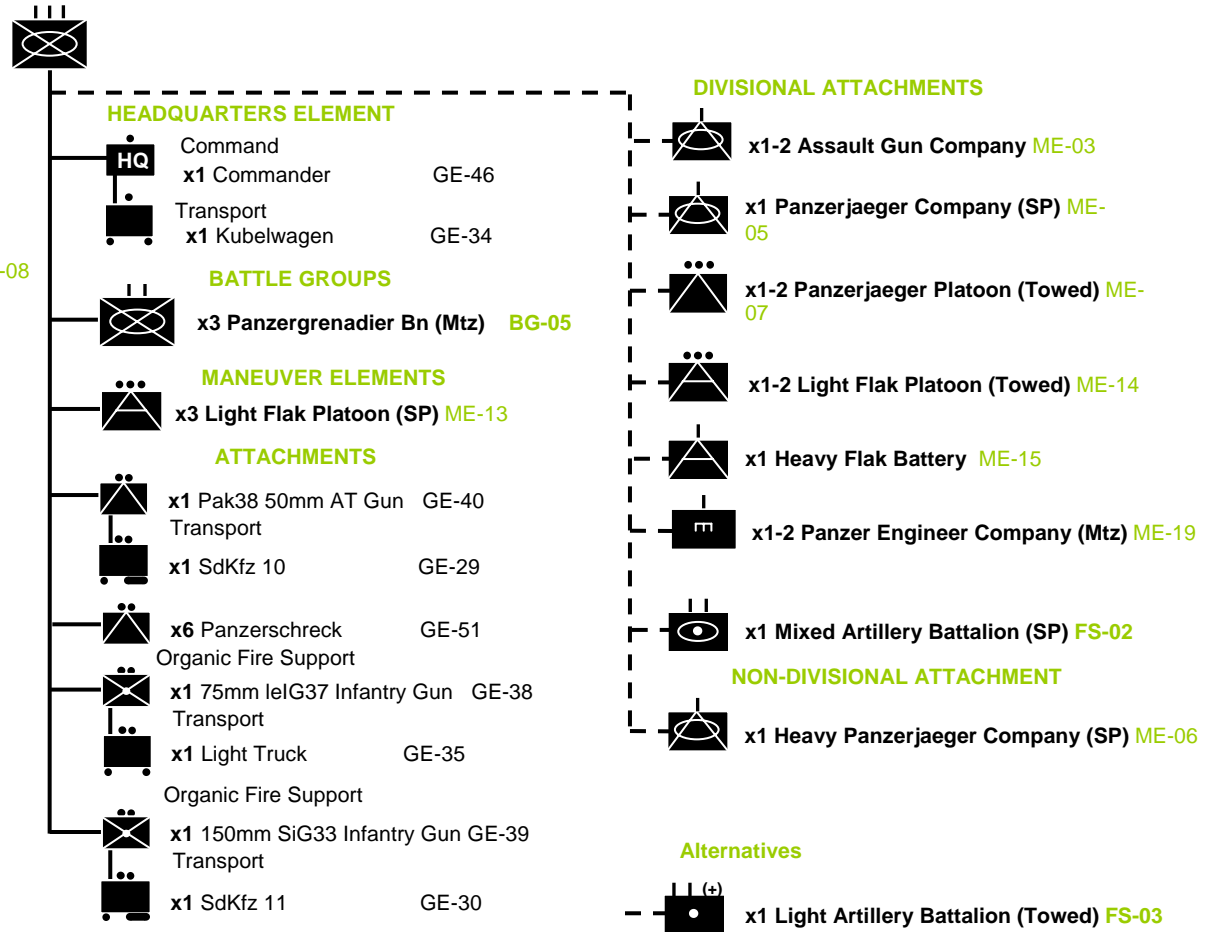

GE BG-07->BG-08

Battle Group-07

Armored Reconnaissance Battalion

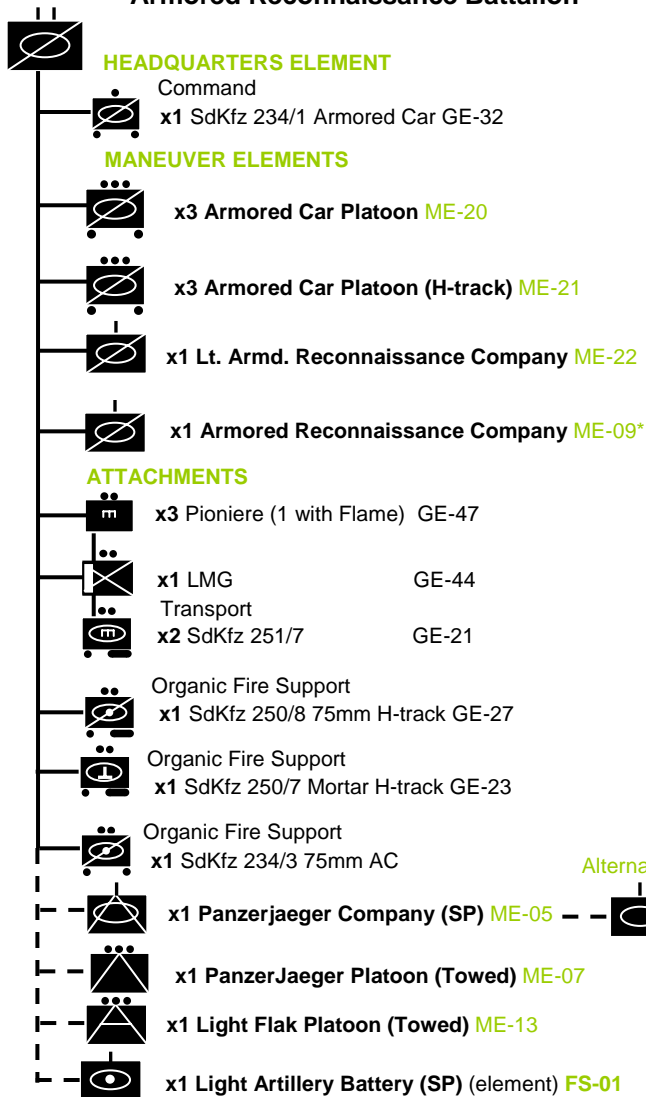

Battle Group-08 Infantry Regiment

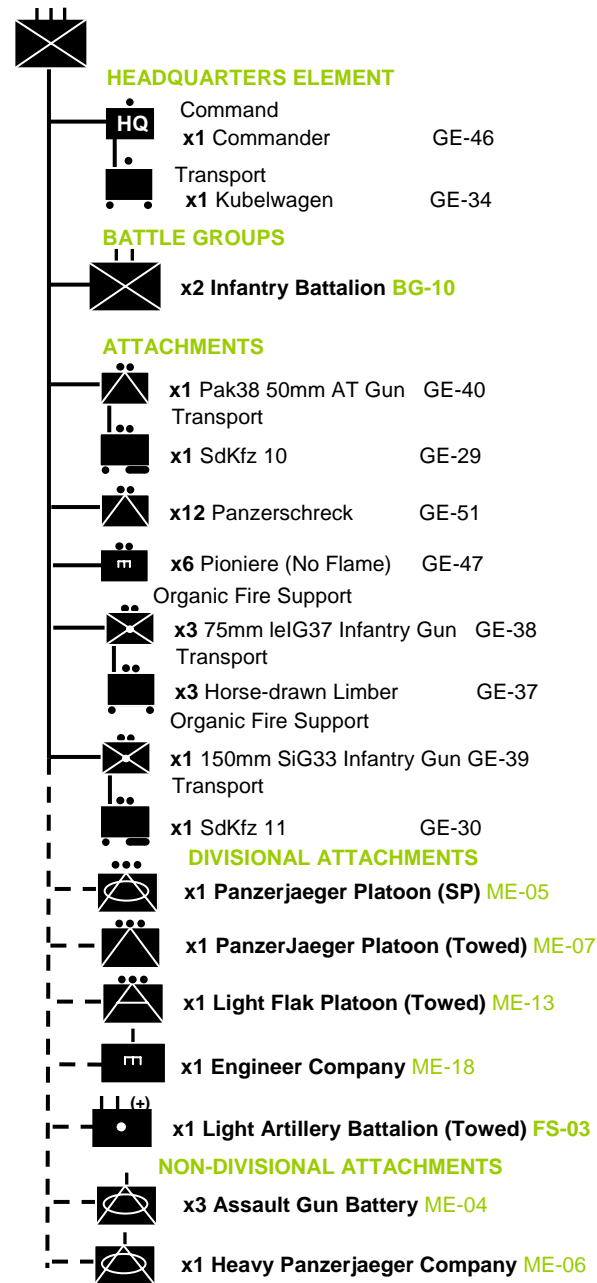

Alternative

x1 Panzer Company ME-01

GE BG-09->BG-11

Battle Group-09

Volksgrenadier Regiment



HEADQUARTERS ELEMENT

- HQ** Command
x1 Commander GE-46
- Transport
x1 Kubelwagen GE-34

BATTLE GROUPS

- x2 Volksgrenadier Battalion **BG-11**

ATTACHMENTS

- x18 Panzerschreck GE-51
- x6 Pioniere (No Flame) GE-47
- Organic Fire Support
- x2 75mm IeIG37 Infantry Gun GE-38
- Transport
- x2 Horse-drawn Limber GE-37

FIRE SUPPORT ELEMENTS

- Off-board Organic Fire Support
- x2 Heavy Mortar Platoon **FS-01**

DIVISIONAL ATTACHMENTS

- x1 Panzerjaeger Platoon (SP) **ME-05**
- x1 Panzerjaeger Platoon (Towed) **ME-07**
- x1 Light Flak Platoon (Towed) **ME-13**
- x1 Engineer Company **ME-18**
- x1 Light Artillery Battalion (105mm) **FS-05**

NON-DIVISIONAL ATTACHMENTS

- x3 Assault Gun Battery **ME-04**
- x1 Heavy Panzerjaeger Company **ME-06**
- x1 Light Artillery Battalion (75mm) **FS-05**

Battle Group-10

Infantry Battalion



- HQ** Command
x1 Commander GE-46

MANEUVER ELEMENTS

- x3 Infantry Company **ME-10**

ATTACHMENTS

- x3 Heavy Machine Gun GE-50
- Organic Fire Support
- x3 80 mm Mortar GE-52

FIRE SUPPORT ELEMENT

- Off-board Organic Fire Support
- x1 Heavy Mortar Platoon **FS-01**

Battle Group-11

Volksgrenadier Battalion



- HQ** Command
x1 Commander GE-46

MANEUVER ELEMENTS

- x3 Volksgrenadier Company **ME-11**

ATTACHMENTS

- x4 Heavy Machine Gun GE-50
- Organic Fire Support
- x3 80 mm Mortar GE-52
- Organic Fire Support
- x2 75mm IeIG37 Infantry Gun GE-38
- Transport
- x2 Horse-drawn Limber GE-37