

Infantry Division 43-45

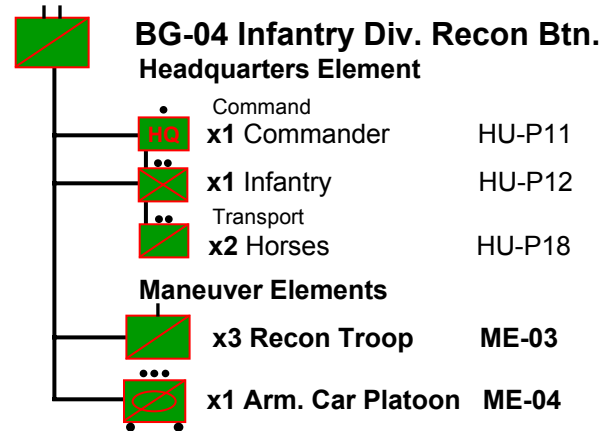

Infantry Division 43-45(2)

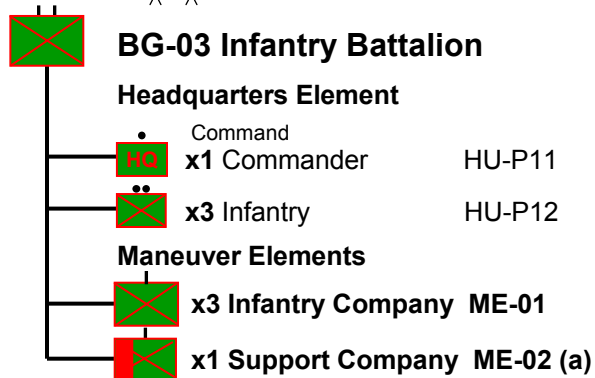
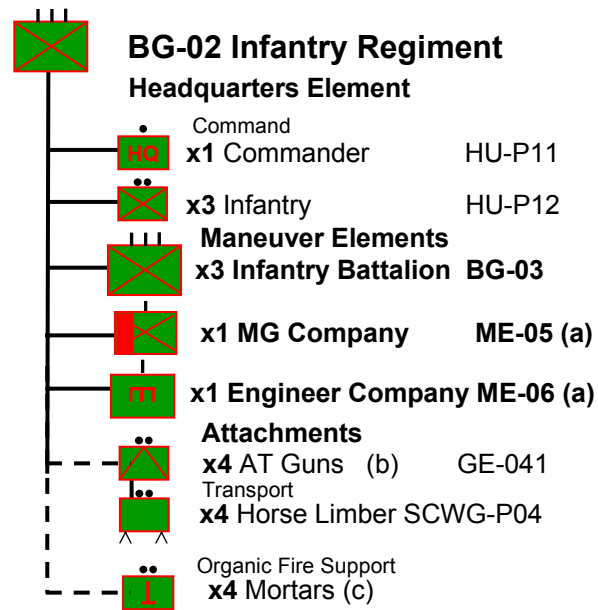
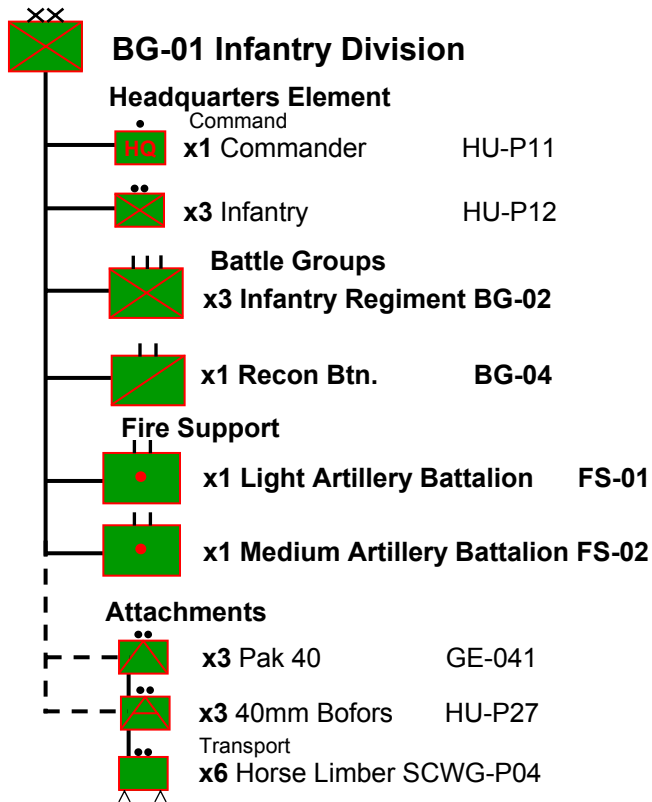
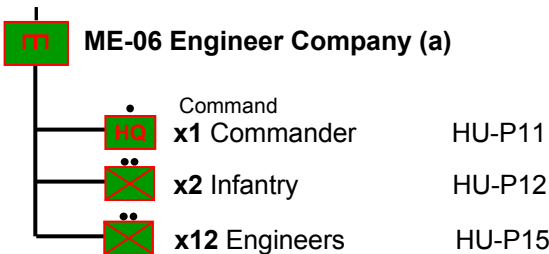
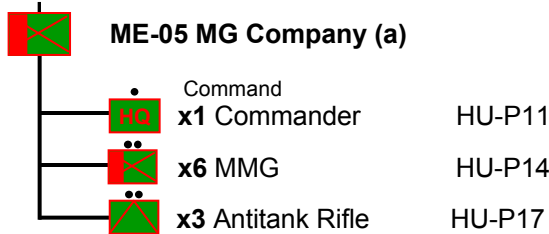
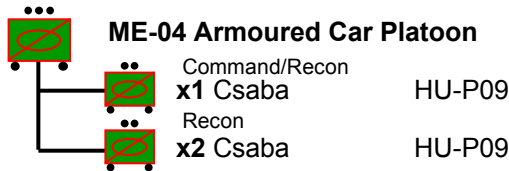
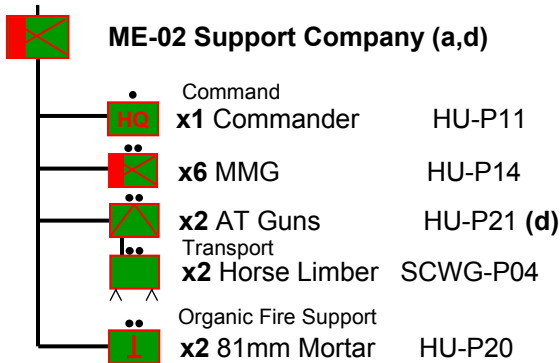
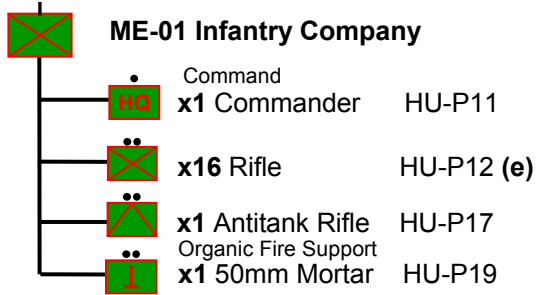

43-45 Infantry Division Notes

- (a) Components may be attached to other maneuver elements or used as a unit.
- (b) May be 3.7cm Pak (HU-P21), 4cm M40(HU-P22) 4.7cm FA-FRC (HU-P23), 4.7cm Pak 36t, Pak 38, or Pak 40
- (c) Either 81mm Mortar (HU-P20) or 50mm Mortar (HU-P19). Attach as organic support to subordinate elements, or attach as organic support to the HQ element.
- (d) May be 3.7cm Pak (HU-P21), 4cm M40(HU-P22) 4.7cm FA-FRC (HU-P23), 4.7cm Pak 36t
- (e) From '44 on 1-4 infantry can have PzFaust

Fire Support Elements

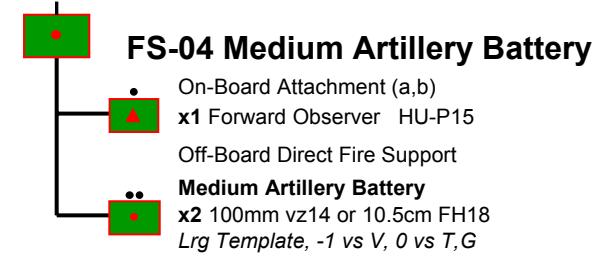
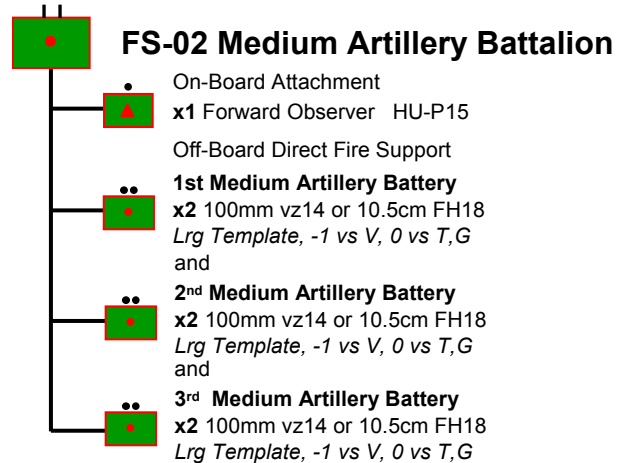
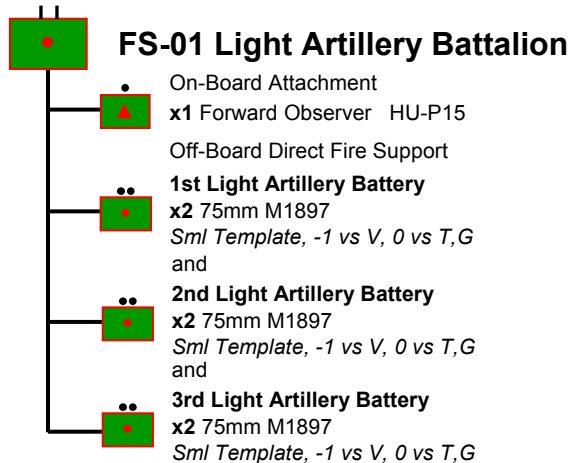

- (a) Only the observer may call fire for the guns.
- (b) The Observer should have appropriate transport (truck/field car or Horse).

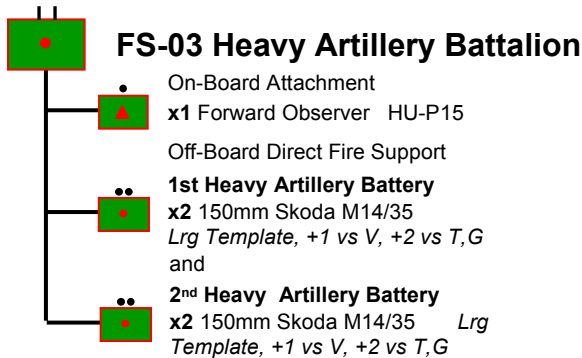

- (a) Only the observer may call fire for the guns.

FOs will usually have appropriate transport, such as field cars or light trucks.

Some Battalions may have more or fewer batteries than the standard number

1st Armored Division 43-45

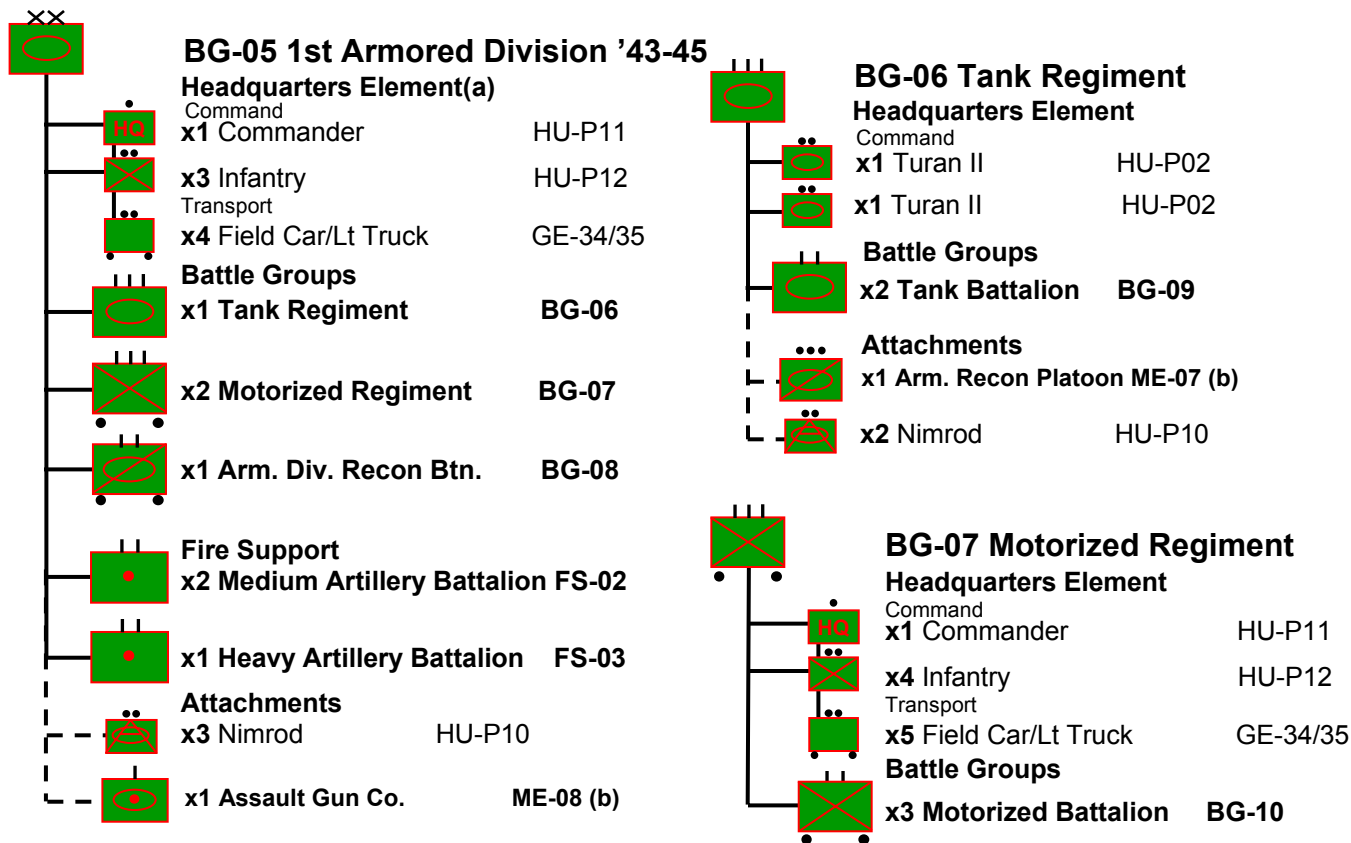

- a) This is a guess. The Armored regimental HQs ride in tanks, while the motorized HQs ride in trucks.
- b) May operate independently as an ME.

1st Armored Division 43-45 (2)

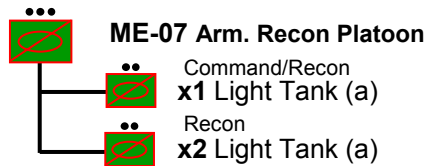
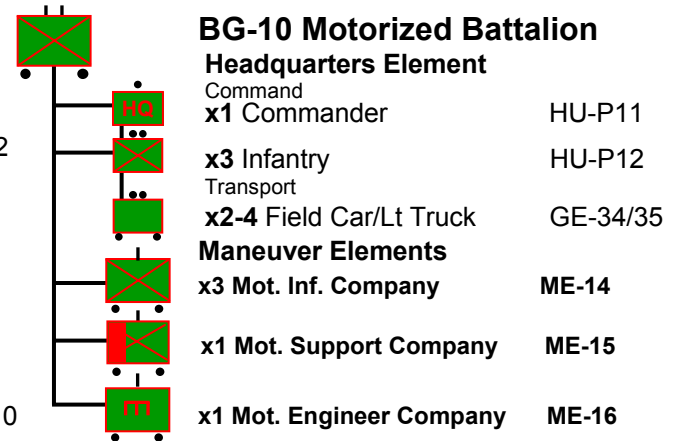
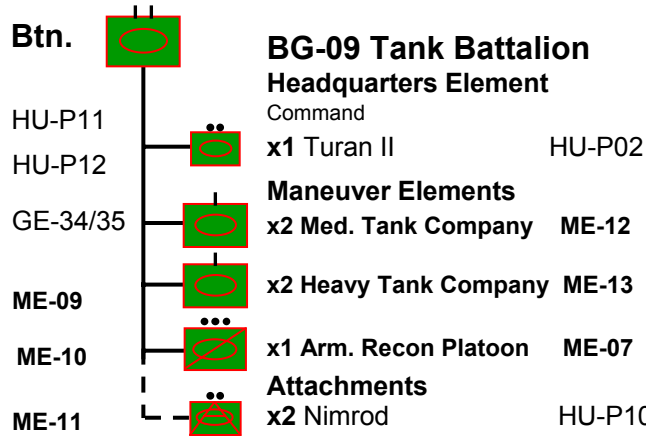
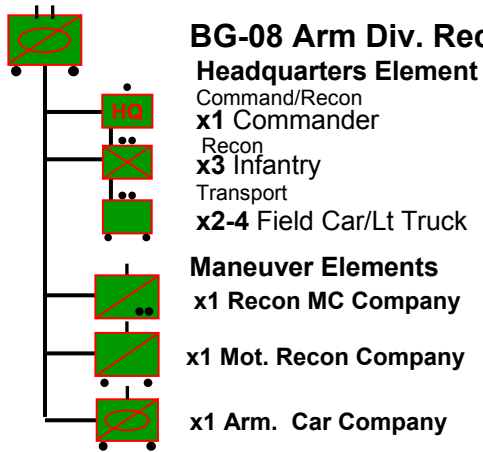

a)
 '42-'43 use PzKpfw Ib (GE-070)
 Apr '43-'44 Toldi II HU-P05.
 '44 on may use Toldi III HU-P06

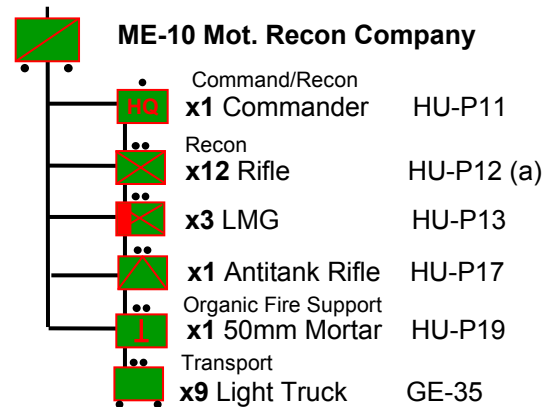
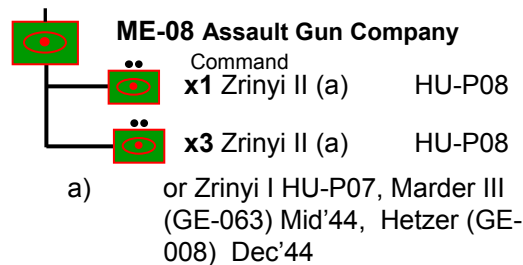

a) From '44, 1-4 infantry can have PzFaust

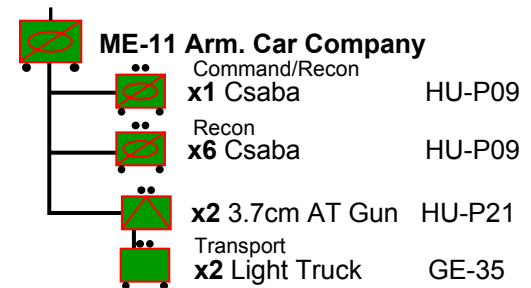
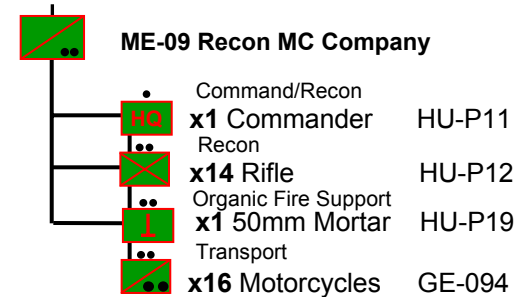

1st Armored Division 43-45 (3)

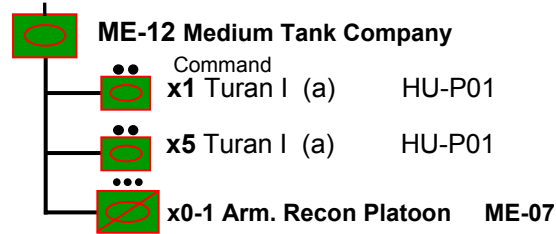

- a)
- Oct42-Mar43 PzKpfw 38t G GE-083
 - Apr43-Sep44 Turan I HU-P01
 - After Sep 44 or PzKpfw IVH GE-03

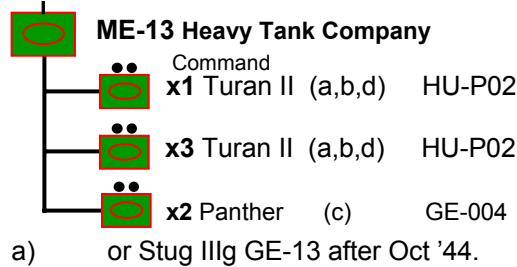

- a) or Stug IIIg GE-13 after Oct '44.
- b) One Heavy company may use PzKpfw VI Tiger after Oct '44
- c) Panthers only available in the Tiger company.
- d) Oct42-Mar43

Different in 1st an 2nd Battalions
In 1st Tank Btn

- HQ: x1 PzKpfw IV F1 GE-79
x2 PzKpfw IV F2 GE-80
x3 PzKpfw IV F1 GE-79

- 2nd Tank Btn
HQ: x1 PzKpfw 38t G GE-083
x2 PzKpfw III J GE-077
x3 PzKpfw 38t G GE-083

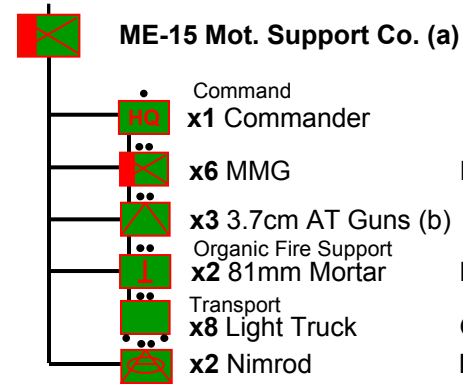
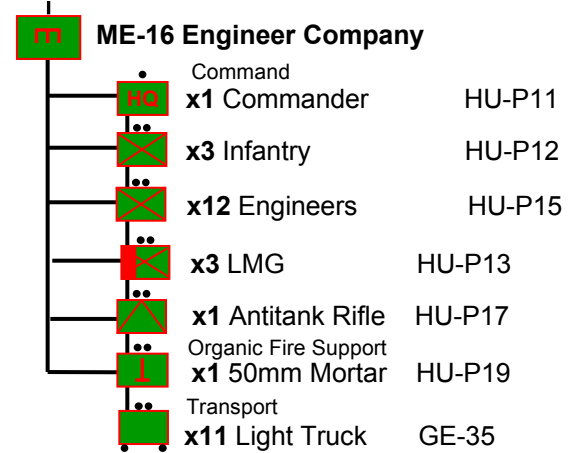

- a) May be attached to other elements in the battalion.
- b) Or 5cm Pak 38 GE-040

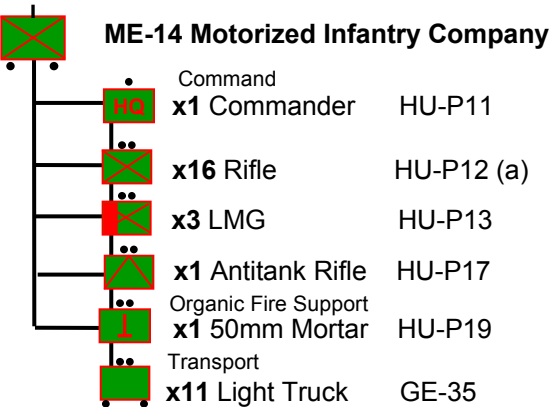

- a) From '44, 1-4 infantry can have PzFaust

1st Armored Division Oct42-Mar43

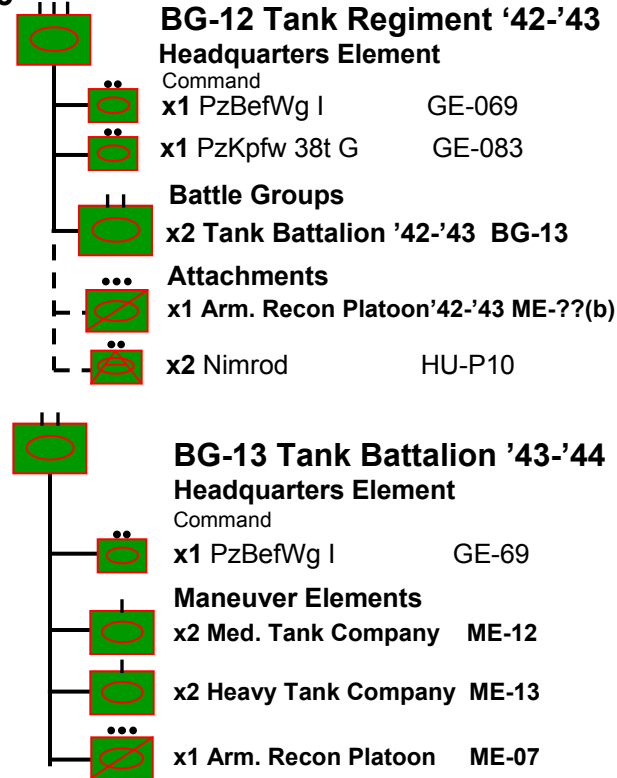
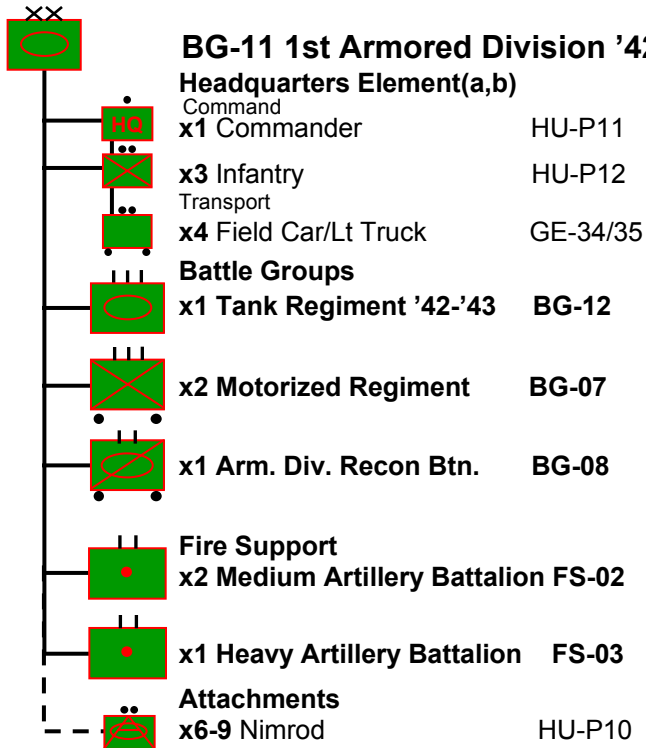

a) This is a guess. The Armored regimental HQs ride in tanks, while the motorized HQs ride in trucks.

b) May be used from June 42, where heavy tank Battalions and Pak 38 are not available

Rapid Corps June-Nov 1941

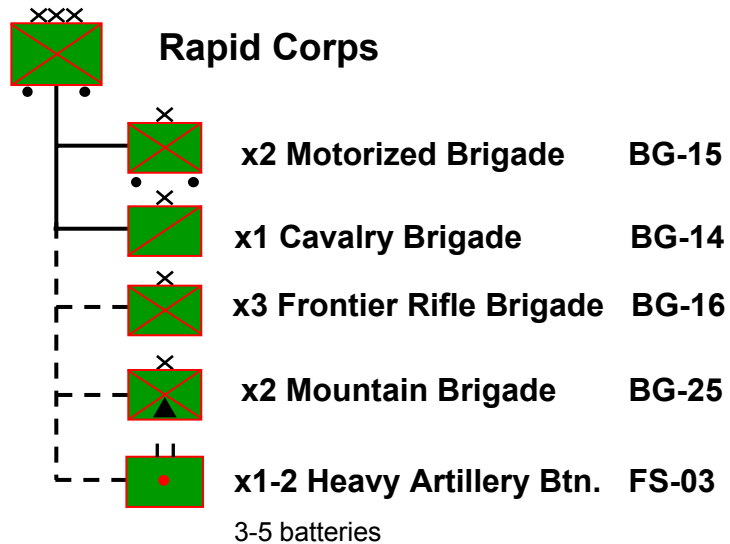

The Rapid Corps joined the invasion of Russia in July 1941 and survived until November, when the survivors were withdrawn and converted to an armored division and a cavalry division. The cavalry and motorized brigades were equivalent to a weak division. Most of the major formations in the Rapid Corps are far above the Battlefront WW2 level, but you can get an idea of the types of troops that were sent into action by the Hungarians.

Rapid Corps (2)

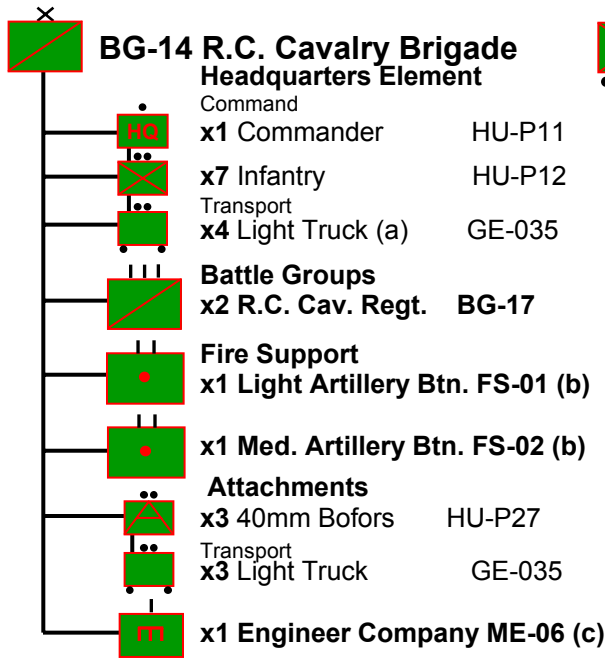

Cav Brigade Notes

- a) Or horses
- b) Only 2 batteries
- c) May also include bridging train

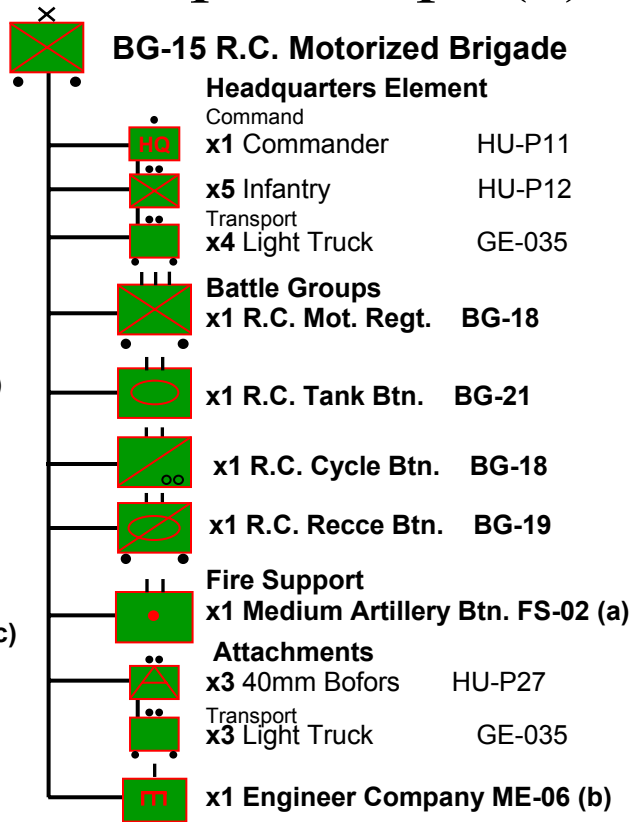

Motorized Brigade Notes

- a) 4 batteries
- b) May also include bridging train

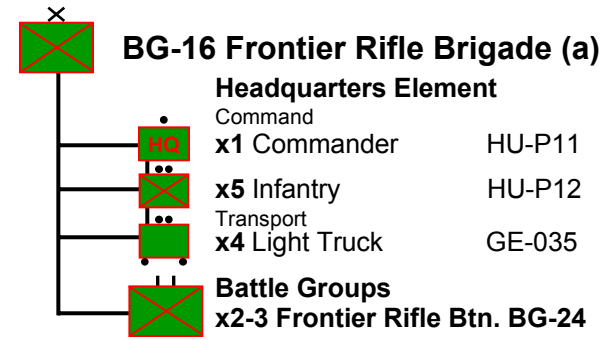

(a) Speculative Organization

Rapid Corps (3)

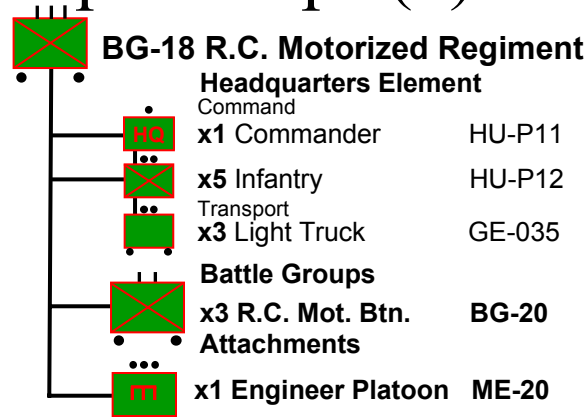
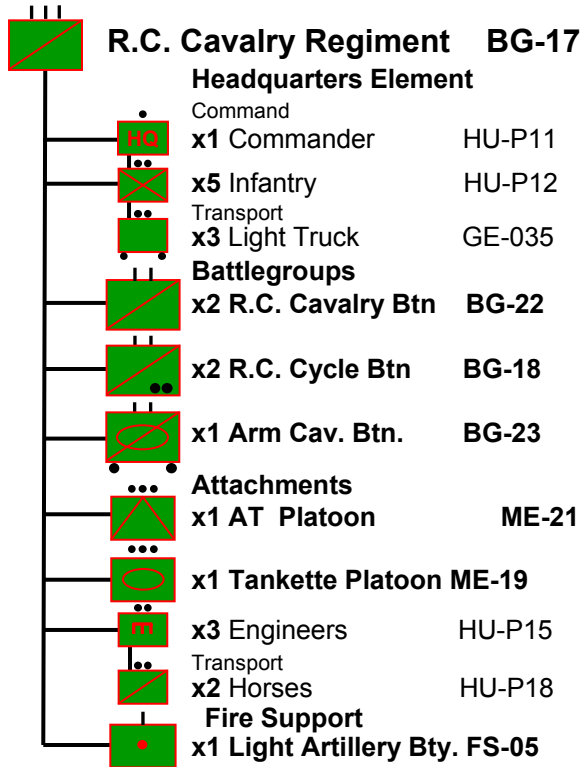

Rapid Corps (4)

June-Nov '41

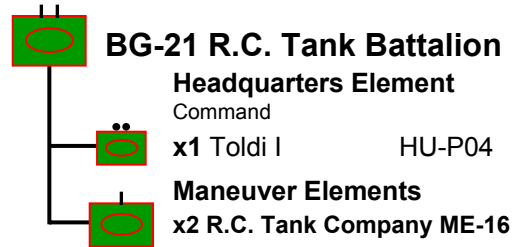
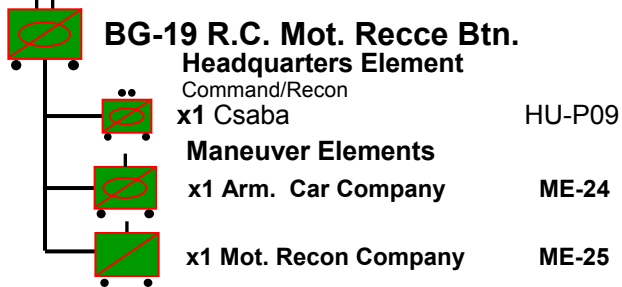
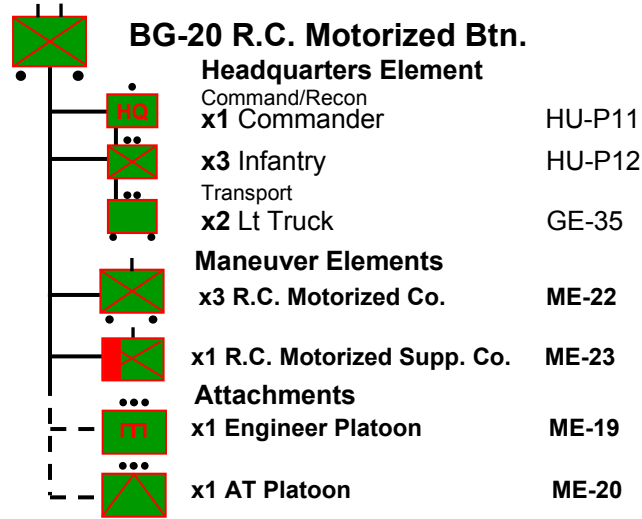
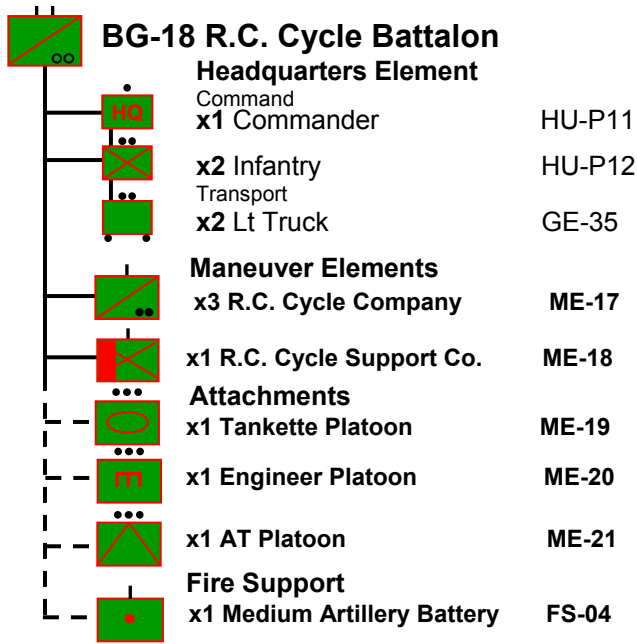

Rapid Corps (5)

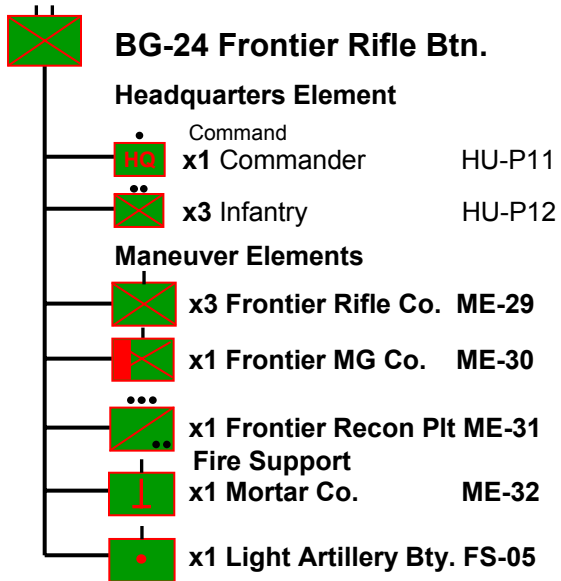
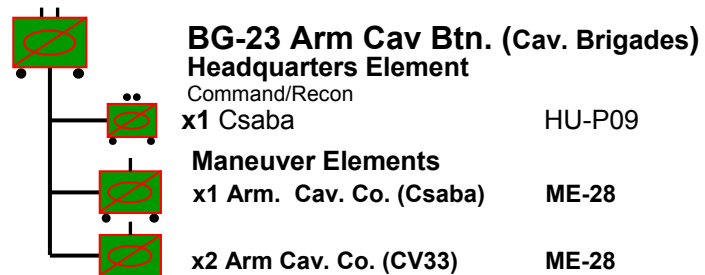
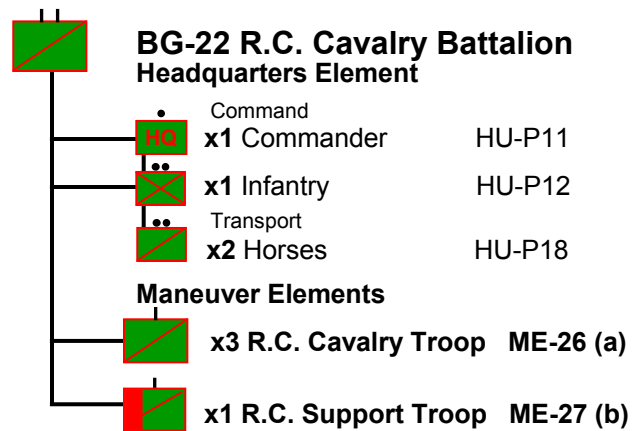

Rapid Corps June-Nov '41 (6)

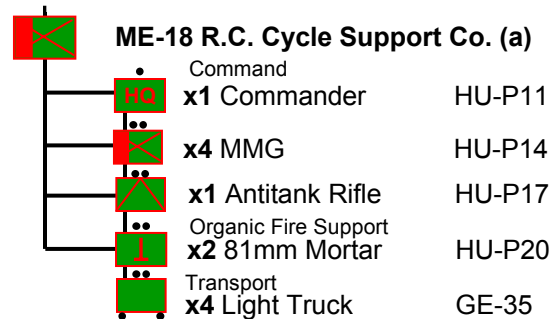
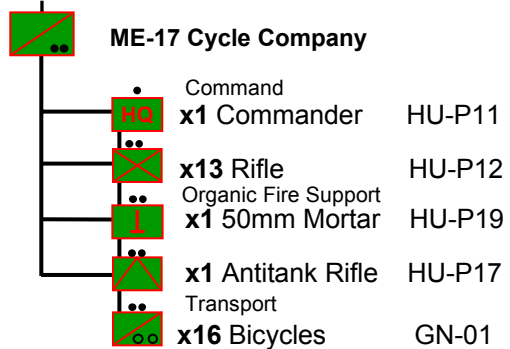
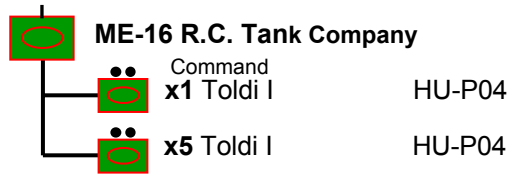

a) May be attached to other elements in the battalion.

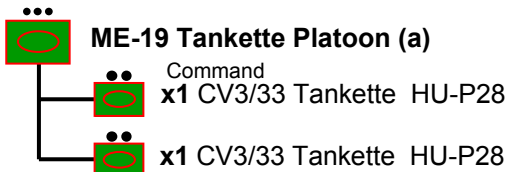

a) May operate as an independent ME or be attached to other MEs in the Battalion

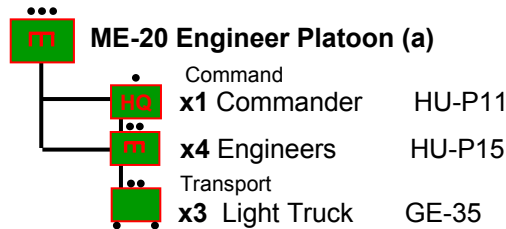

a) May operate as an independent ME or be attached to other MEs in the Battalion

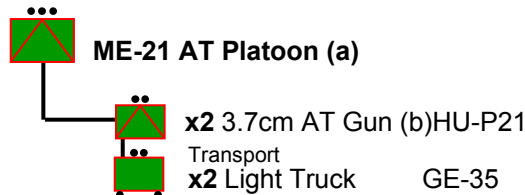

a) Attach to other MEs in the battalion
b) Or 4cm 40M HU-P22

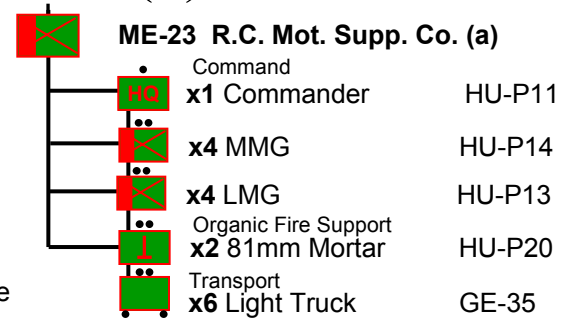
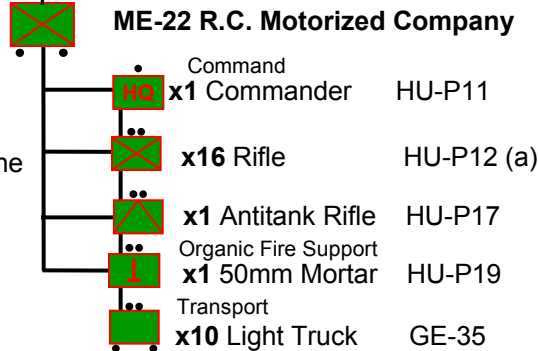

a) May be attached to other elements in the battalion.

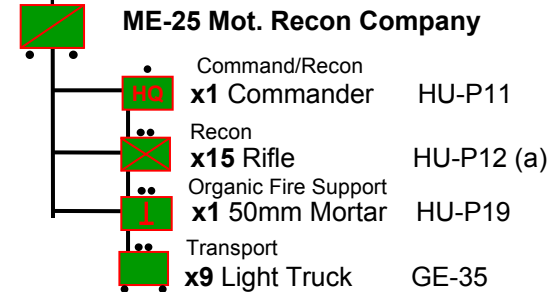
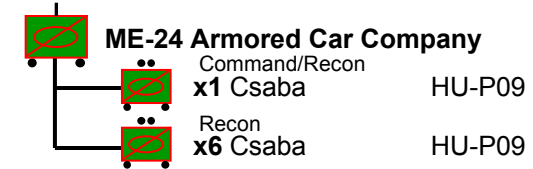

Rapid Corps (7)

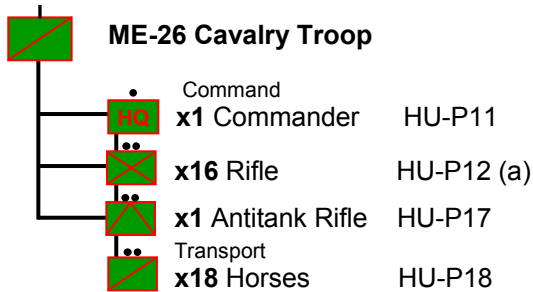

a) Reduce by 8 infantry/horses by July 1941

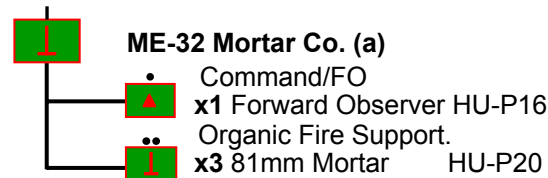
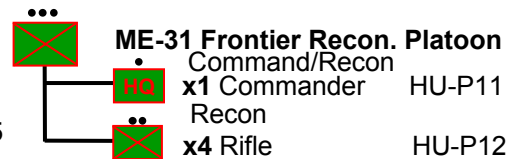
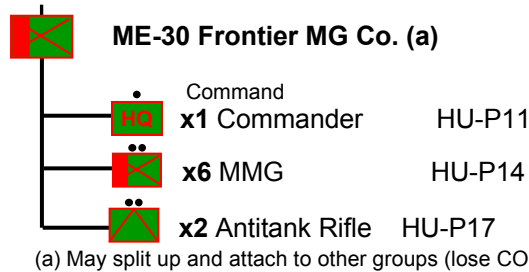
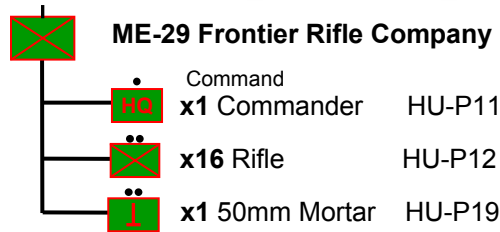
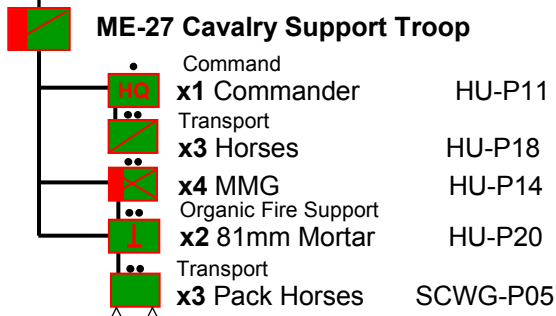

- (a) May split up and attach to other groups (lose FO). Company CO acts as CO
- (b) If firing as a company, only FO may direct fire. Attach FO to another ME, but mortars may be on-board.

Mountain Brigade

1939-45

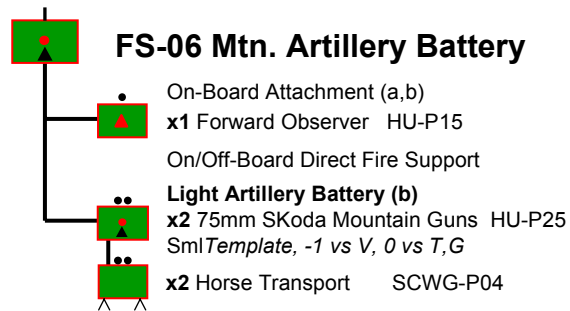
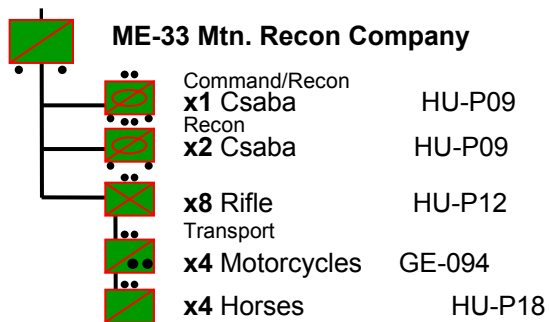
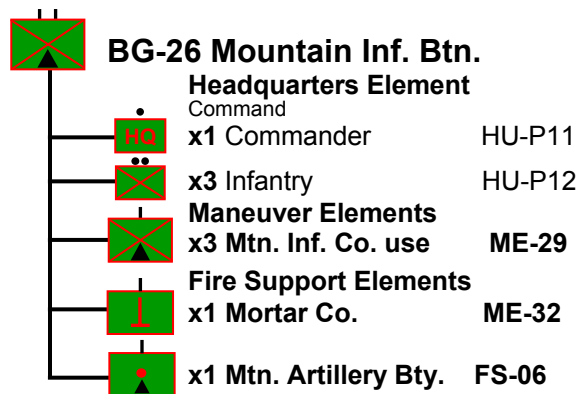
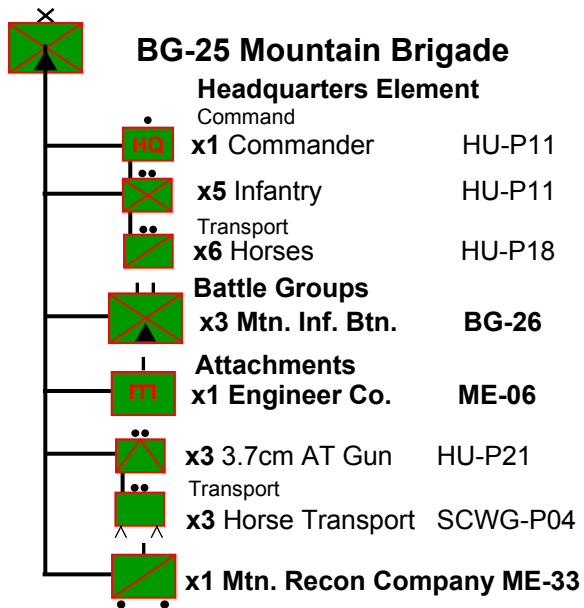

- (a) Only the observer may call fire for the guns.
- (b) Guns may operate either on or off-board.

Light Inf Division 1941-43

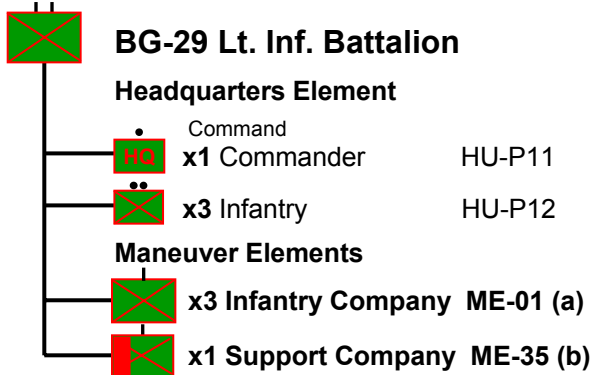
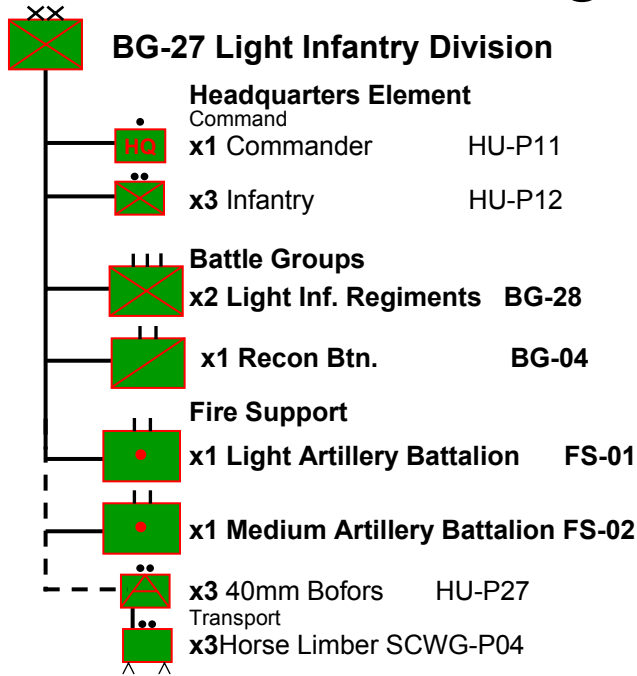

(a) No 50mm Mortars

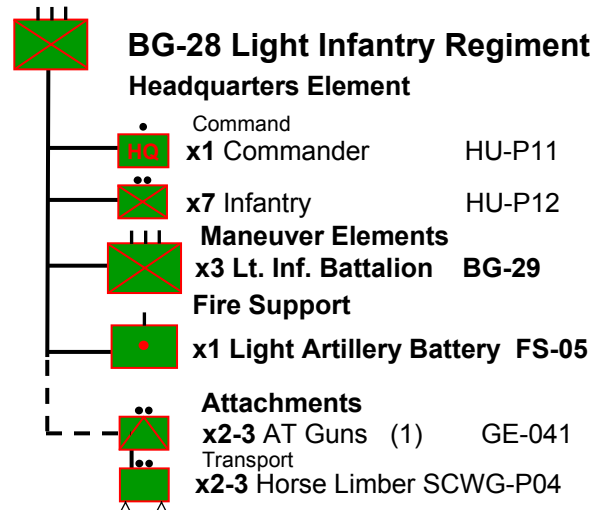

Light Infantry Regt. Notes

- (a) May be 3.7cm Pak (HU-P21), 4cm M40(HU-P22) 4.7cm FA-FRC (HU-P23), 4.7cm Pak 36t, From October 42 Pak 38, or Pak 40

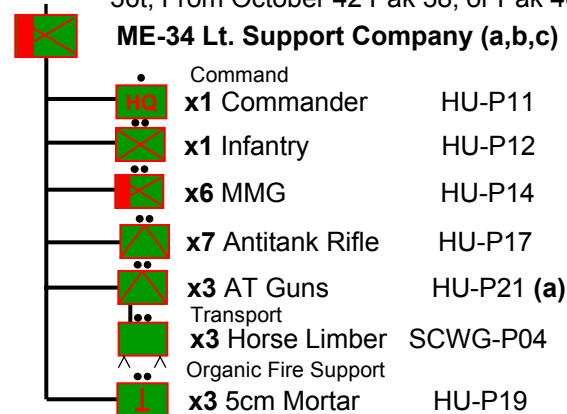

- (a) May be 3.7cm Pak (HU-P21), 4cm M40(HU-P22) 4.7cm FA-FRC (HU-P23), 4.7cm Pak 36t From October 42 Pak 38, or Pak 40
- (b) May be deployed as attachments to other MEs
- (c) Alt organization-replace 3MMG, 1 ATR with 6 LMG HU-P13.

Cavalry Division 42-45

BG-33 Recon Btn.

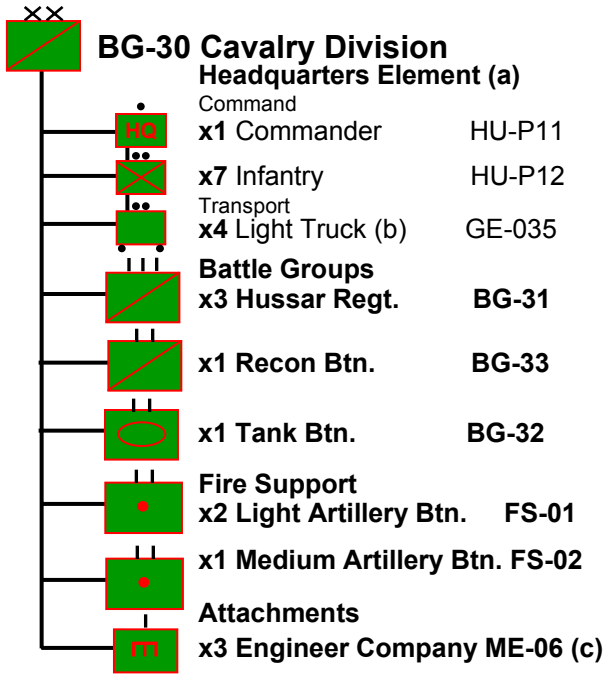

Cav Division Notes

- a) HQ organization is a guess based on other formations
- b) Or horses

Cavalry Division (2)

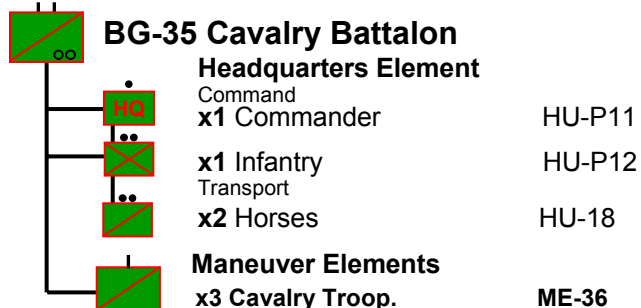
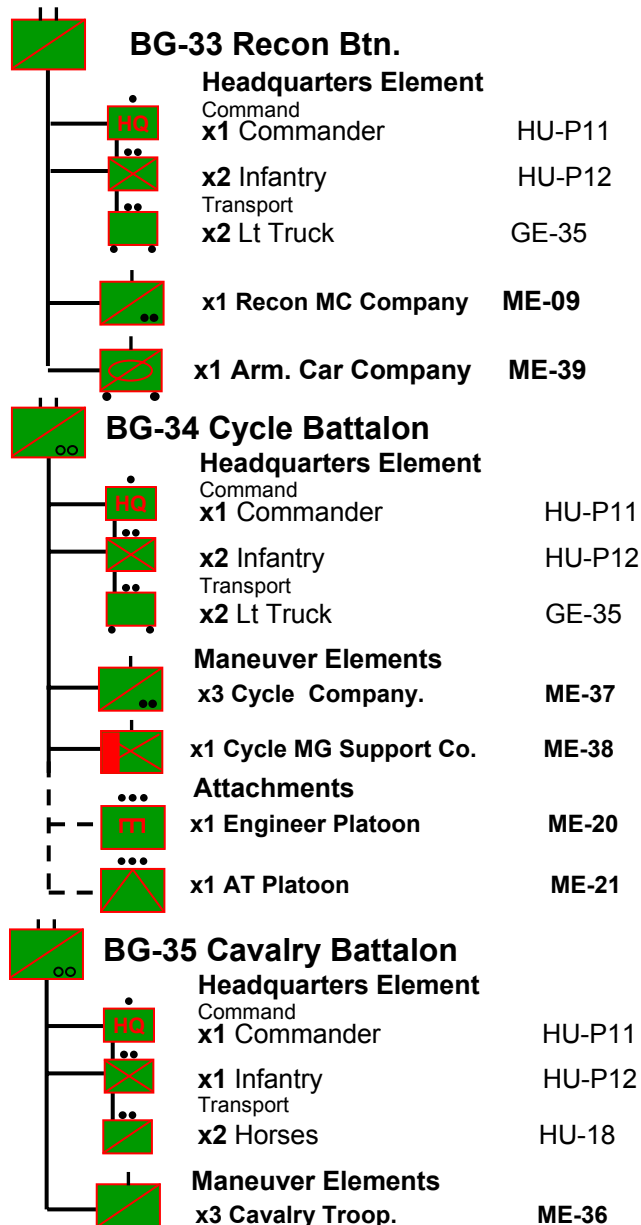
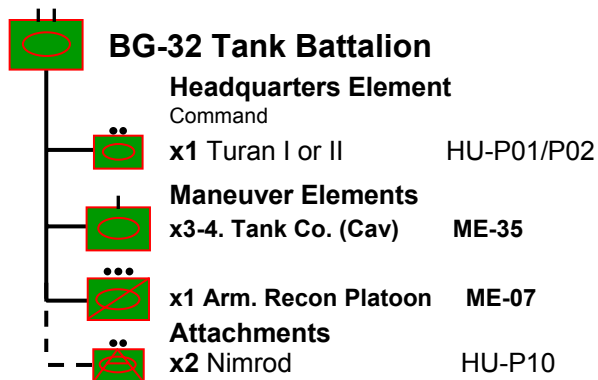
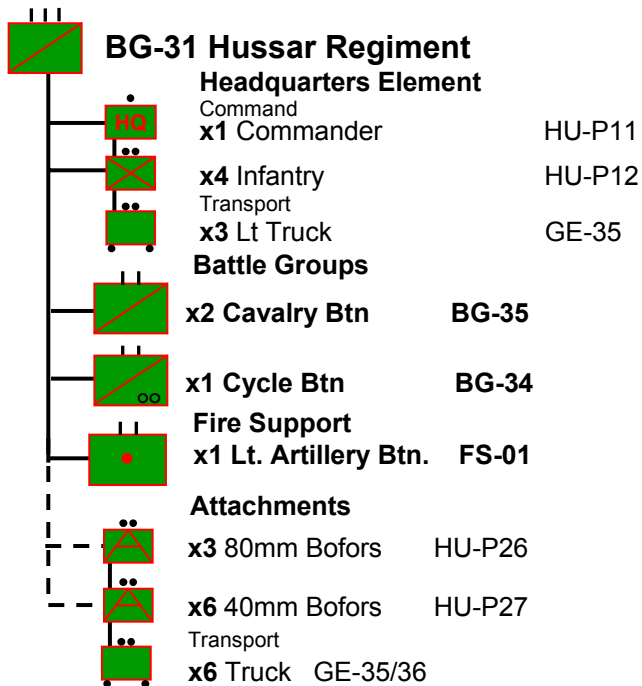

Cavalry Division (3)

