

# 10. SS-Panzer-Division 'Fruindsberg' at Hill 112, 10th July 1944

## SS-Brigadeführer Heinz Harmel Commanding

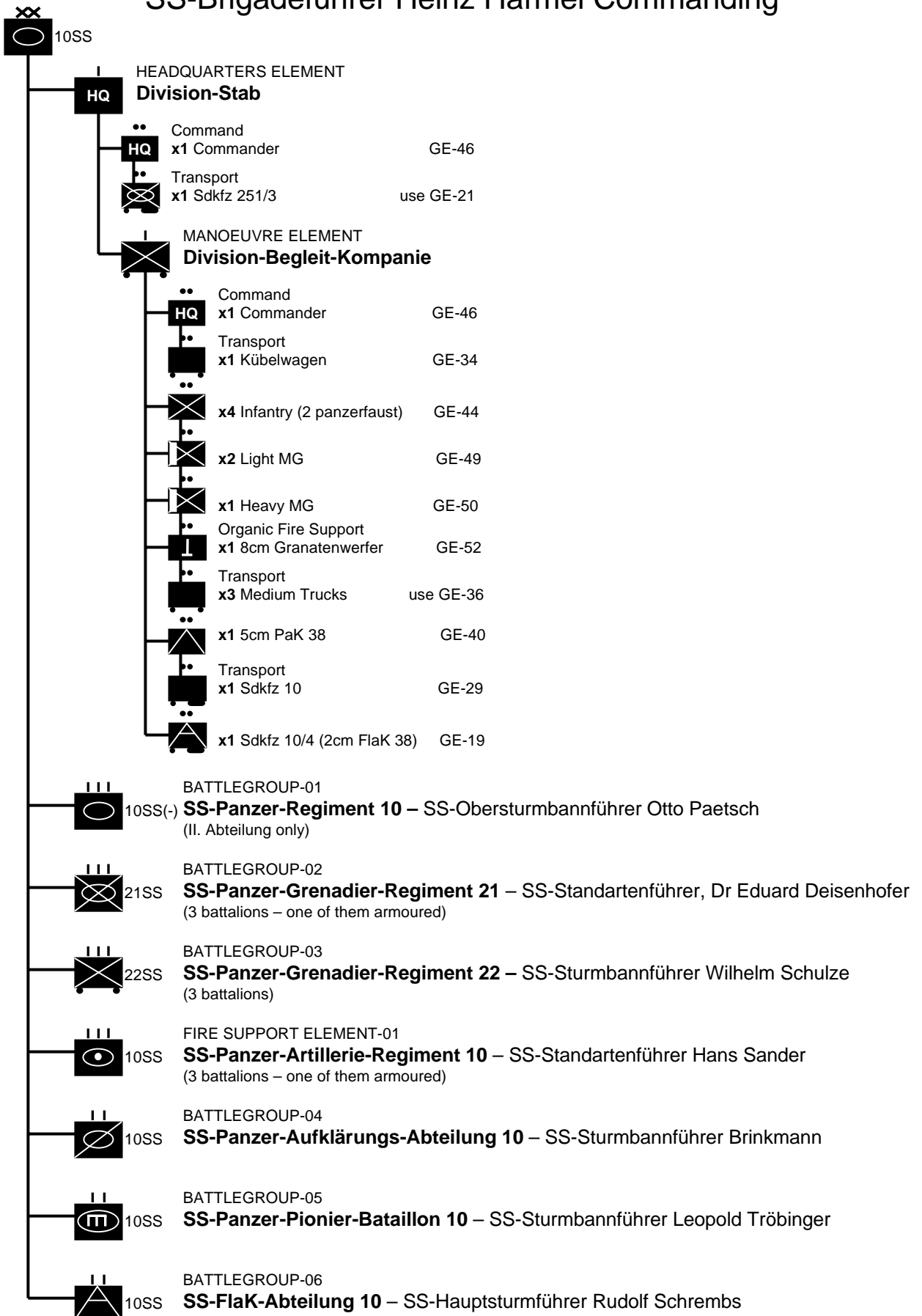

# SS-Panzer-Regiment 10

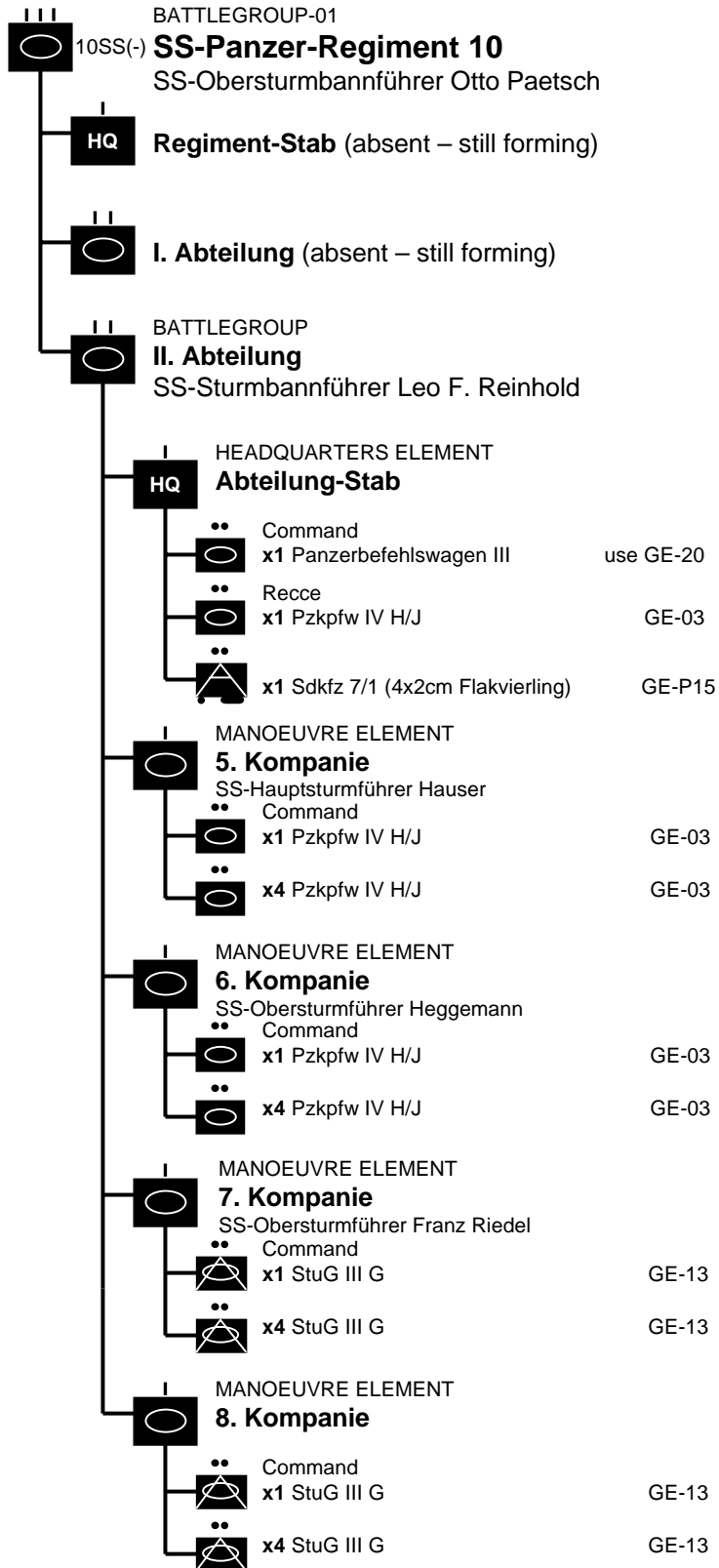

# SS-Panzer-Grenadier-Regiment 21

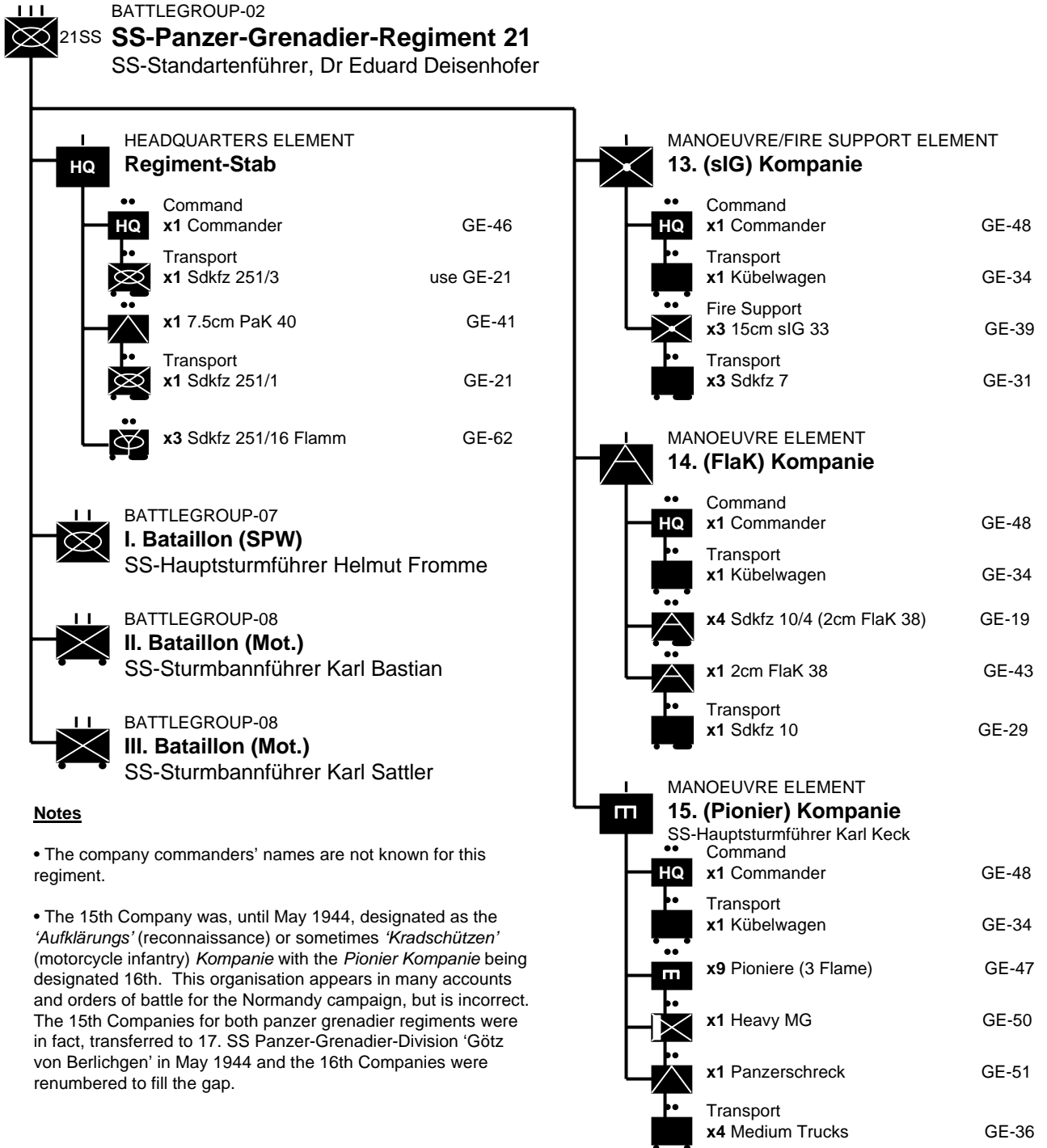

## Notes

- The company commanders' names are not known for this regiment.
- The 15th Company was, until May 1944, designated as the 'Aufklärungs' (reconnaissance) or sometimes 'Kradschützen' (motorcycle infantry) *Kompanie* with the *Pionier Kompanie* being designated 16th. This organisation appears in many accounts and orders of battle for the Normandy campaign, but is incorrect. The 15th Companies for both panzer grenadier regiments were in fact, transferred to 17. SS Panzer-Grenadier-Division 'Götz von Berlichgen' in May 1944 and the 16th Companies were renumbered to fill the gap.

# SS-Panzer-Grenadier-Regiment 22

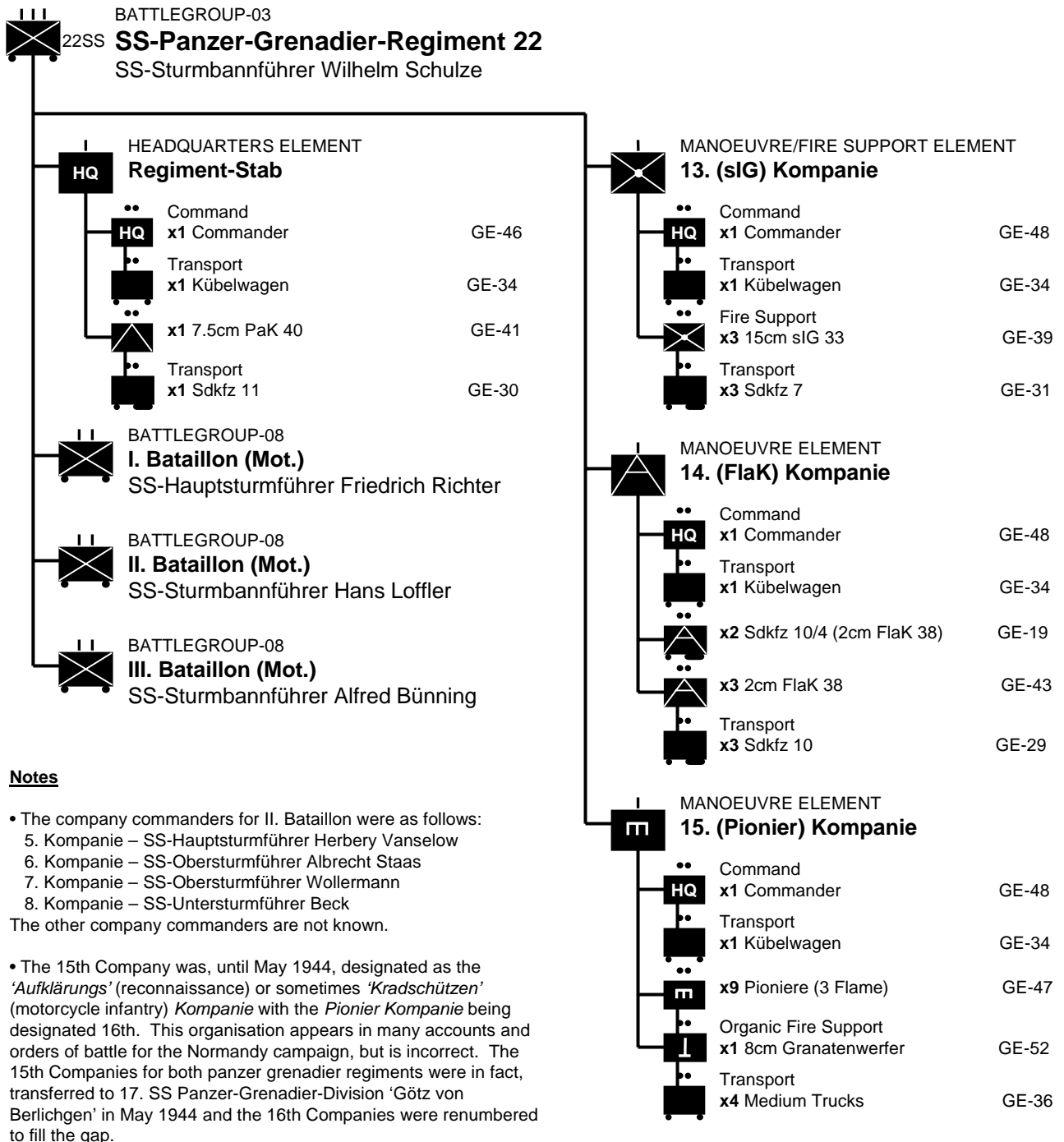

## Notes

- The company commanders for II. Bataillon were as follows:
  5. Kompanie – SS-Hauptsturmführer Herbery Vanselow
  6. Kompanie – SS-Obersturmführer Albrecht Staas
  7. Kompanie – SS-Obersturmführer Wollermann
  8. Kompanie – SS-Untersturmführer Beck
 The other company commanders are not known.

• The 15th Company was, until May 1944, designated as the 'Aufklärungs' (reconnaissance) or sometimes 'Kradschützen' (motorcycle infantry) Kompanie with the Pionier Kompanie being designated 16th. This organisation appears in many accounts and orders of battle for the Normandy campaign, but is incorrect. The 15th Companies for both panzer grenadier regiments were in fact, transferred to 17. SS Panzer-Grenadier-Division 'Götz von Berlichgen' in May 1944 and the 16th Companies were renumbered to fill the gap.

# SS-Panzer-Aufklärungs-Abteilung 10

BATTLEGROUP-04  
 10SS **SS-Panzer-Aufklärungs-Abteilung 10**  
 SS-Sturmbannführer Brinkmann

**HQ HEADQUARTERS ELEMENT**  
**Abteilung-Stab**  
 Command/Recce  
 x1 Commander GE-46  
 Transport/Recce  
 x1 Sdkfz 250/3 use GE-26

**MANOEUVRE ELEMENT**  
**1. (Panzer-Spähwagen) Kompanie**  
 SS-Obersturmführer Karl Ziebrecht  
 Command/Recce  
 x1 Sdkfz 223 use GE-90  
 Recce  
 x2 Sdkfz 221/223 use GE-90  
 Recce  
 x6 Sdkfz 222 GE-91  
 Recce  
 x3 Sdkfz 232 GE-92

**MANOEUVRE ELEMENT**  
**2. (Panzer-Spähwagen) Kompanie**  
 SS-Obersturmführer Hinze  
 Command/Recce  
 x1 Commander GE-46  
 Transport/Recce  
 x1 Sdkfz 250/3 use GE-26  
 Recce  
 x3 Infantry (1 panzerfaust) GE-44  
 Transport/Recce  
 x3 Sdkfz 250/1 GE-26  
 Recce  
 x8 Sdkfz 250/9 GE-28

**MANOEUVRE ELEMENT**  
**3. (Leichte-Panzer-Aufklärungs) Kompanie**  
 SS-Obersturmführer Rudolf Harmstorf  
 Command/Recce  
 x1 Commander GE-46  
 Transport/Recce  
 x1 Sdkfz 250/10 use GE-22  
 Recce  
 x9 Infantry (3 panzerfaust) GE-44  
 Recce  
 x3 Heavy MG GE-50  
 Transport/Recce  
 x12 Sdkfz 250/1 GE-26  
 Organic Fire Support/Recce  
 x1 Sdkfz 250/7 use GE-23

**MANOEUVRE ELEMENT**  
**4. (Leichte-Panzer-Aufklärungs) Kompanie**  
 SS-Obersturmführer Pauli  
 Command/Recce  
 x1 Commander GE-46  
 Transport/Recce  
 x1 Sdkfz 250/9 (a) GE-28  
 Recce  
 x9 Infantry (3 panzerfaust) GE-44  
 Recce  
 x3 Heavy MG GE-50  
 Transport/Recce  
 x12 Sdkfz 250/1 GE-26  
 Organic Fire Support/Recce  
 x1 Sdkfz 250/7 use GE-23

**ATTACHMENTS**  
**5. (Schwere-Panzer-Aufklärungs) Kompanie**  
 SS-Obersturmführer Frank  
 Recce  
 x3 Pioniere (1 flame) GE-47  
 Transport/Recce  
 x3 Sdkfz 251/7 GE-89  
 Organic Fire Support/Recce  
 x2 Sdkfz 251/9 GE-24  
 Organic Fire Support  
 x1 7.5cm IeIG 18 GE38  
 x1 7.5cm PaK 40 GE-41  
 Transport/Recce  
 x2 Sdkfz 251/1 GE-21

(a) The Sdkfz 250/9 armoured car may transport the commander of 4. Kompanie

# SS-Panzer-Pionier-Bataillon 10 & SS-FlaK-Abteilung 10

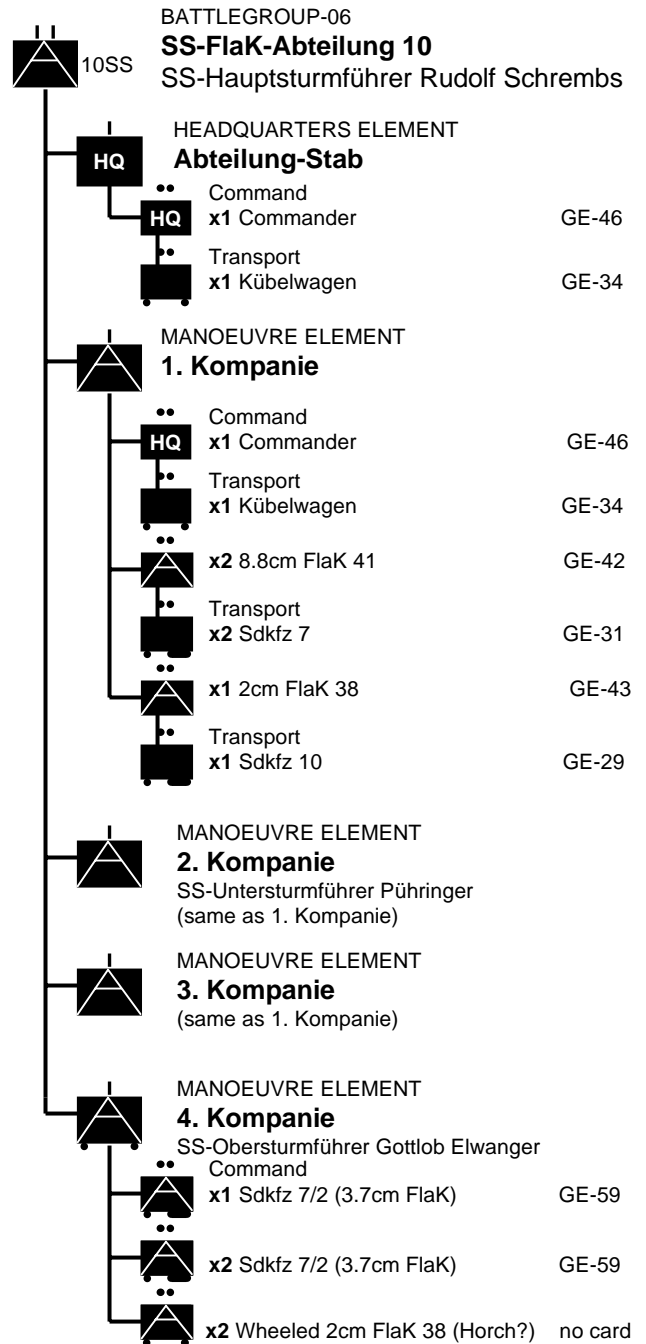
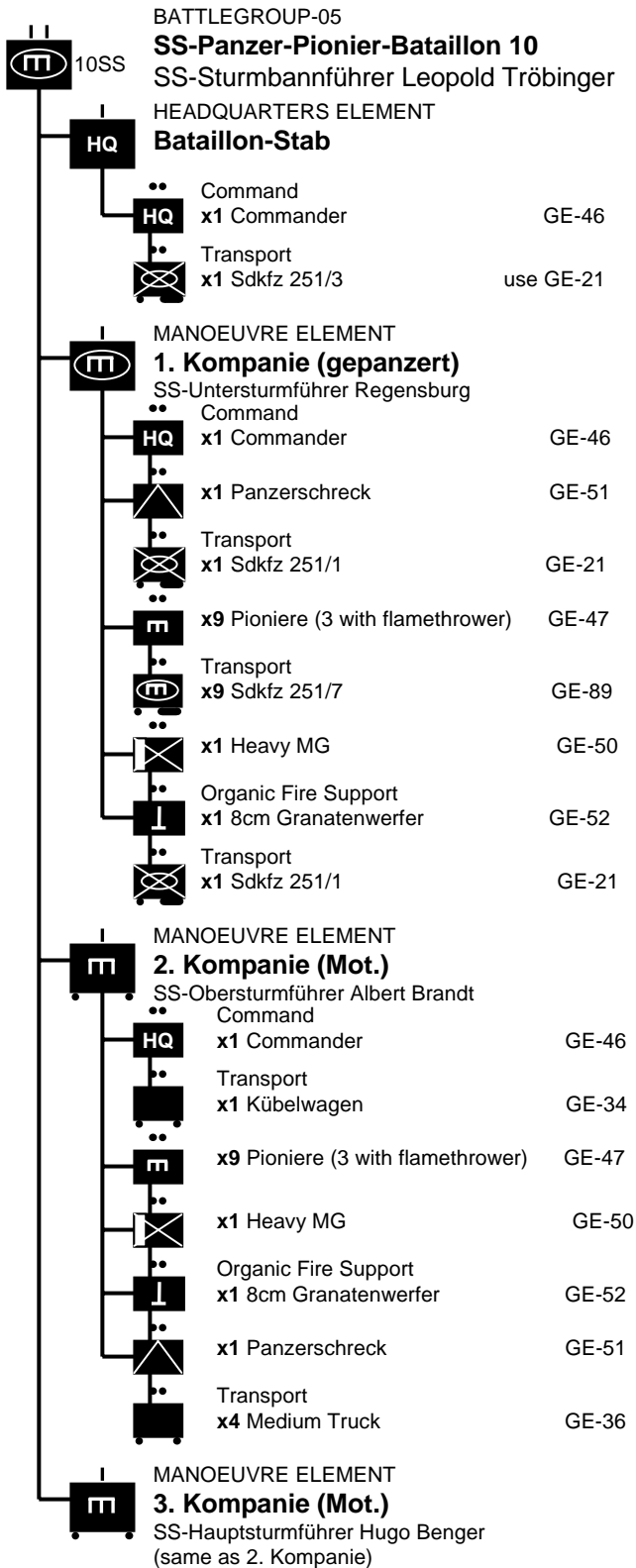

# SS-Panzer-Artillerie-Regiment 10

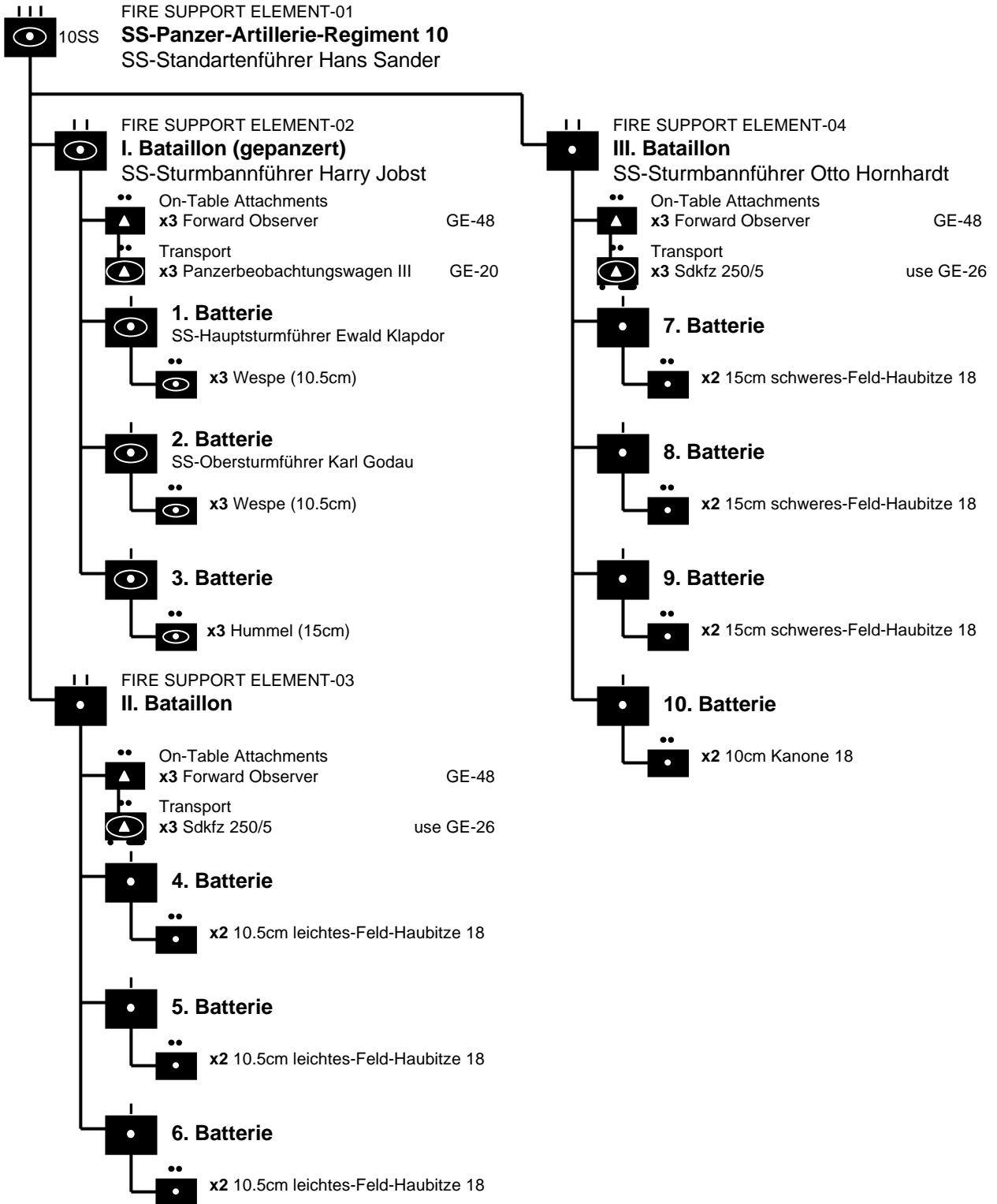

# Panzer-Grenadier Battalion Organisations (BG-07 & BG-08)

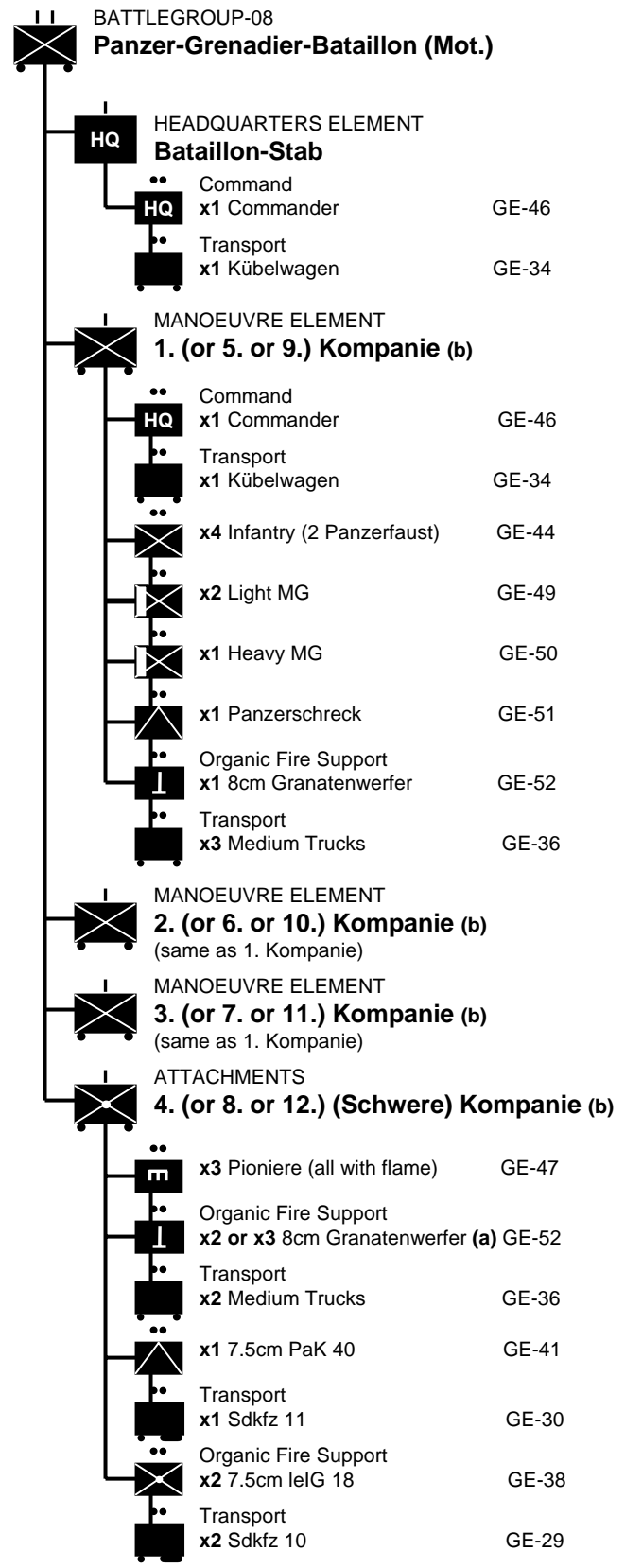
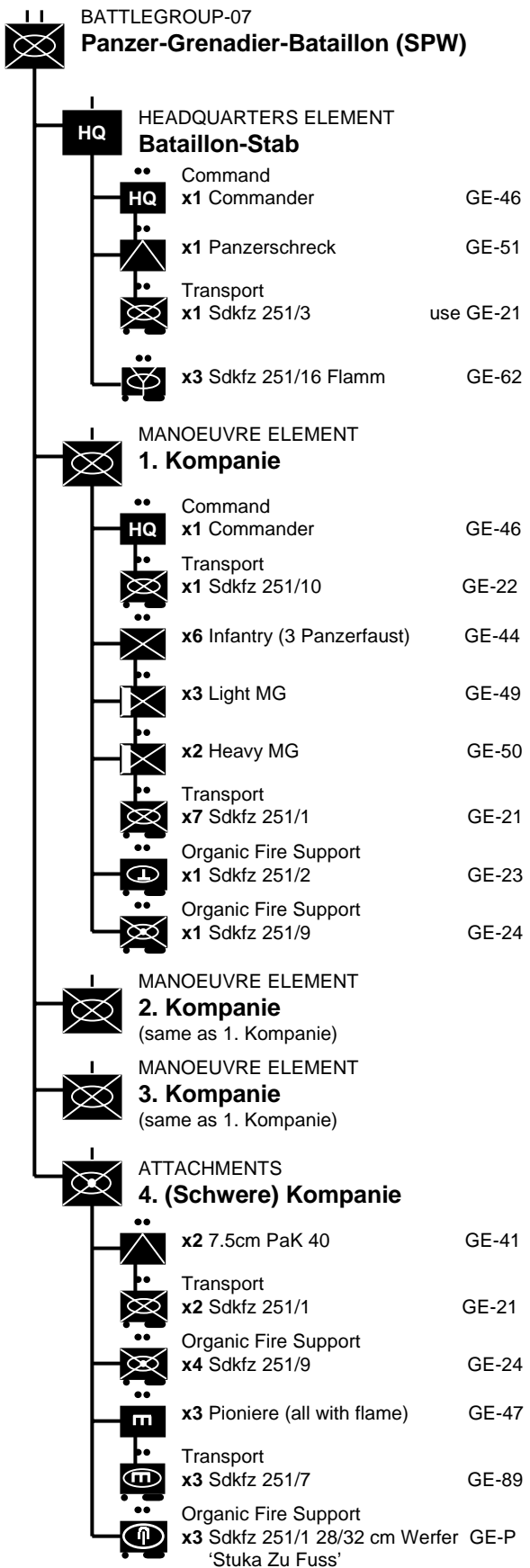

(a) 2x mortars in the battalions of SS PzGren Regt 21 and 3x mortars in the battalions of SS PzGren Regt 22.  
(b) Companies were numbered sequentially through the regiment, so I. Btn would have 1-4 Companies, II. Btn would have 5-8 and so on.



# Attached Elements, II. SS-Panzer-Korps Troops (SS-Schweres-Panzer-Abteilung 102 & Elements, 9. SS-Panzer-Division 'Hohenstaufen')

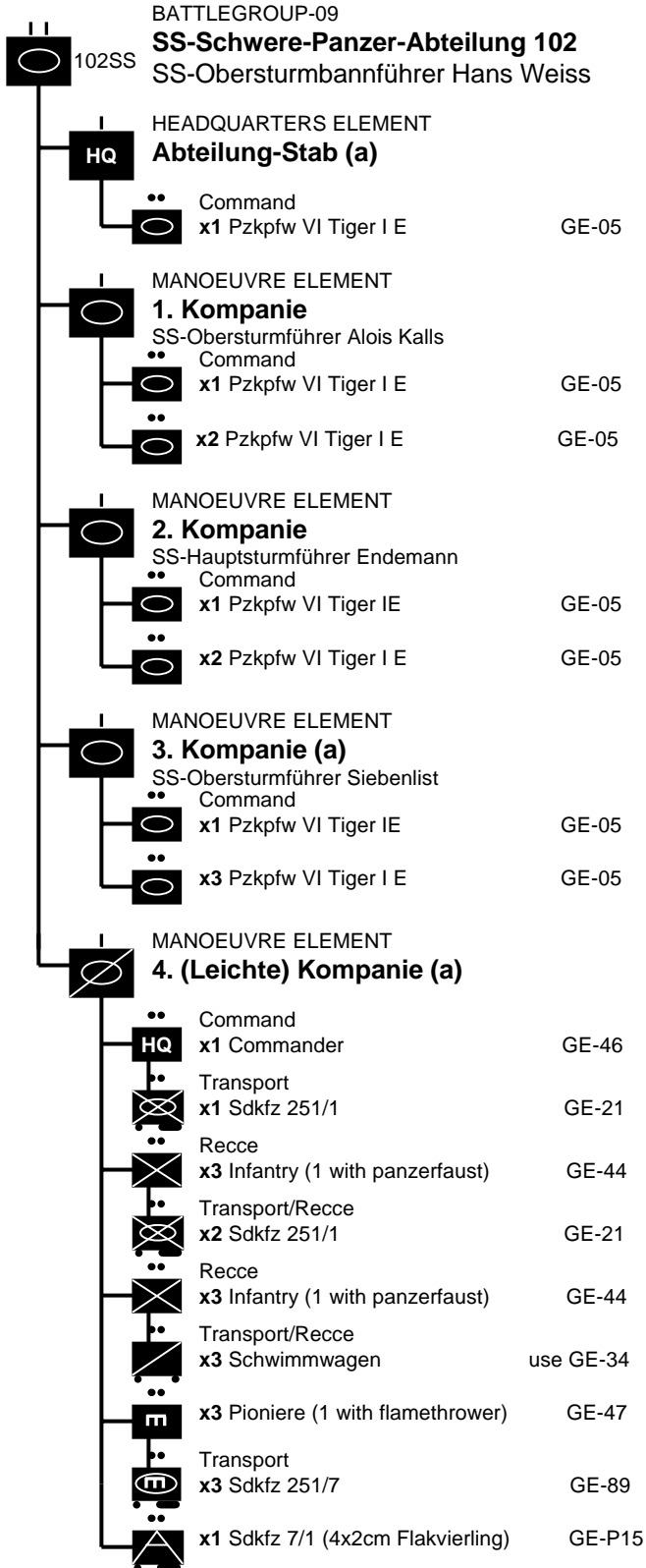

(a) These elements were not apparently engaged on 10th July – only 1. Kompanie and 2. Kompanie were employed against Operation 'Jupiter'. However, they would undoubtedly have been engaged had the British 4th Armoured Brigade been committed to the battle as originally planned.

(b) Note that despite this being their first engagement in Normandy, the battalion was quite understrength on 10th July. This was due to the mechanical unreliability of the Tiger, exacerbated by a road march to the front.

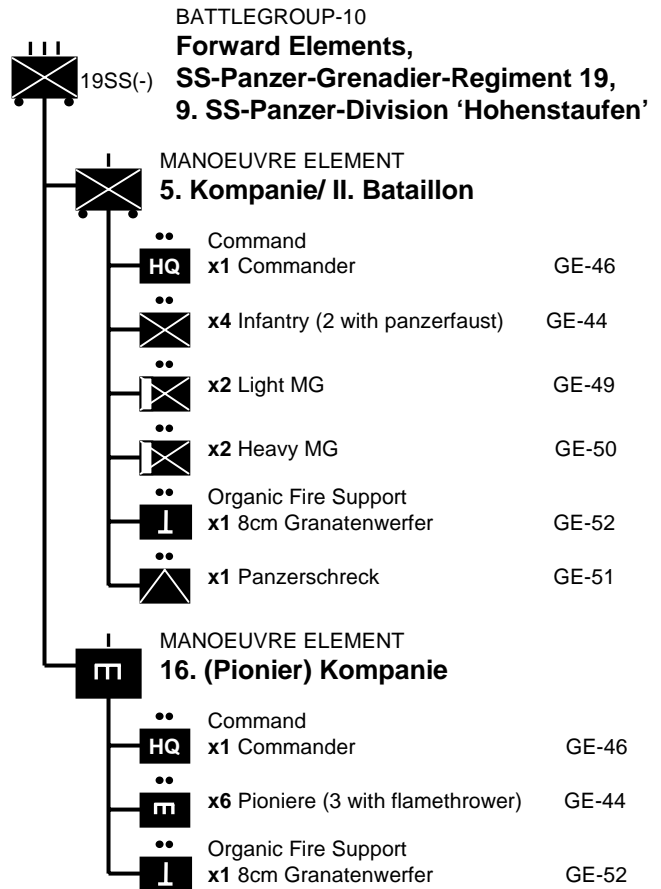

(a) These elements were involved in the evening counter-attacks against 5 DCLI on the crest of Hill 112. They had been forced to leave their transport behind and march to the battlefield on foot, as the lines of communication were jammed by Frundsberg's and Werfer Brigade 8's supply echelons. Most of the divisional artillery was also ready for action by 0200hrs 11th July and Hohenstaufen was involved in counter-attacks throughout 11th July and beyond.

# Attached Elements, II. SS-Panzer-Korps Troops (Werfer-Brigade 8)

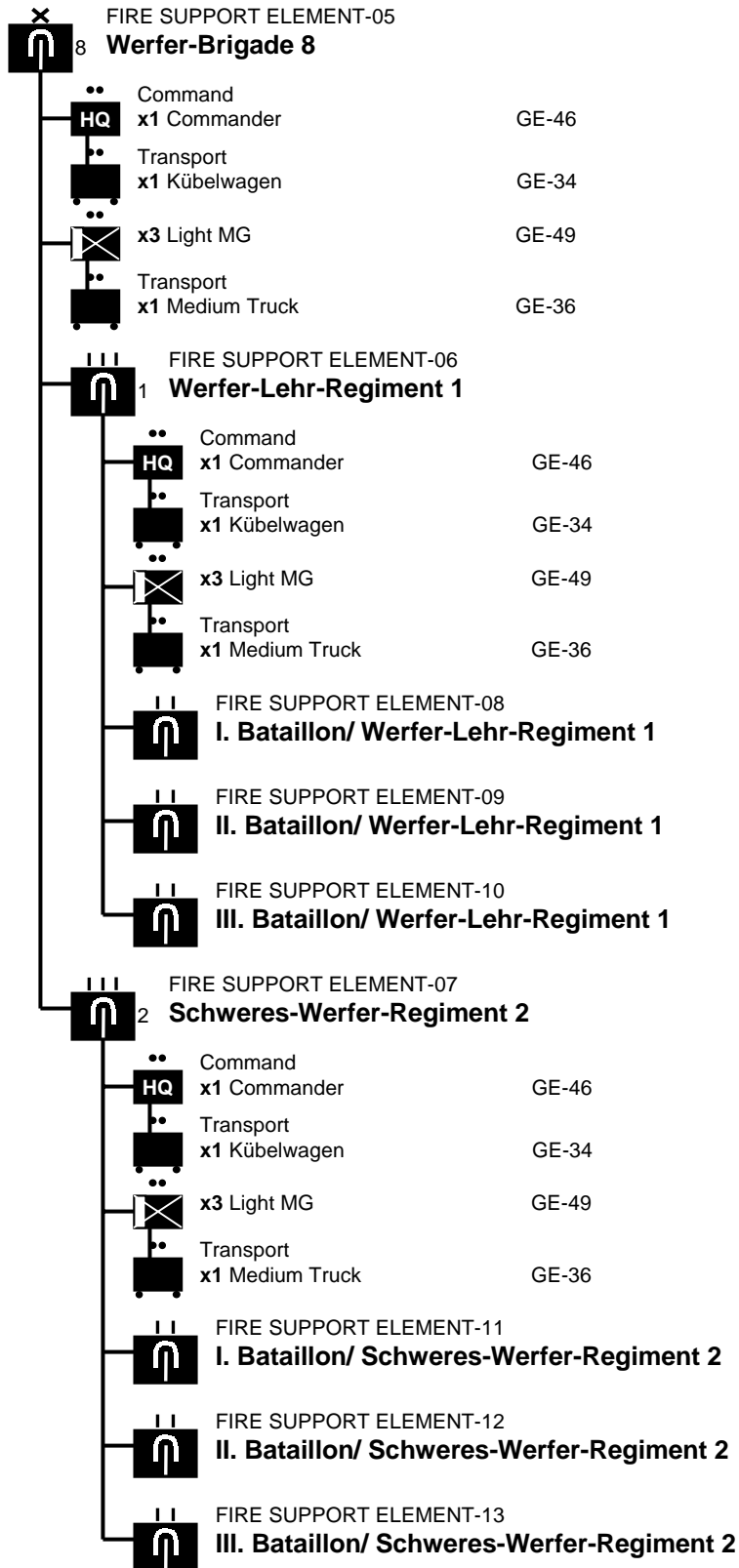

# Attached Elements, II. SS-Panzer-Korps Troops (Werfer Battalion Organisations #1)

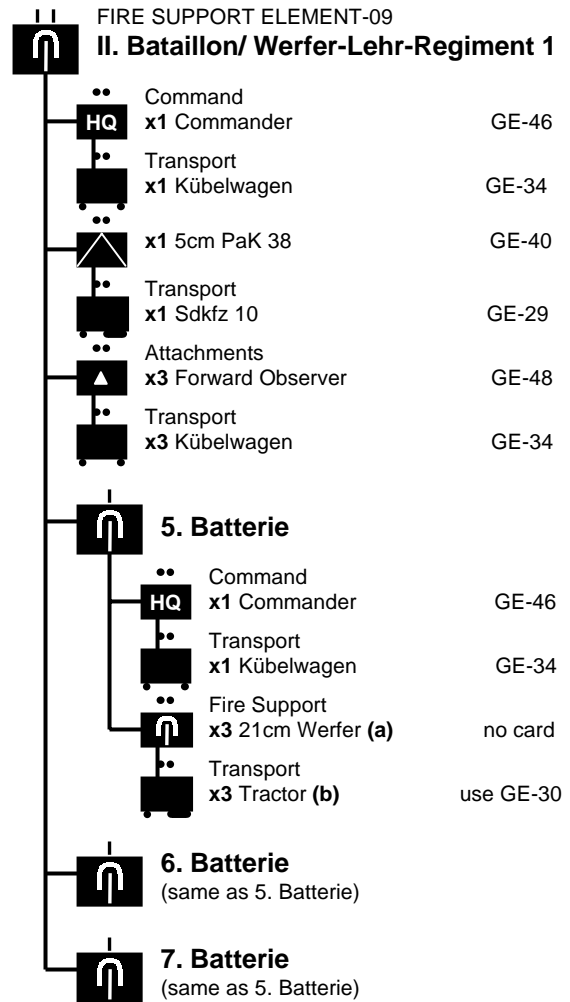
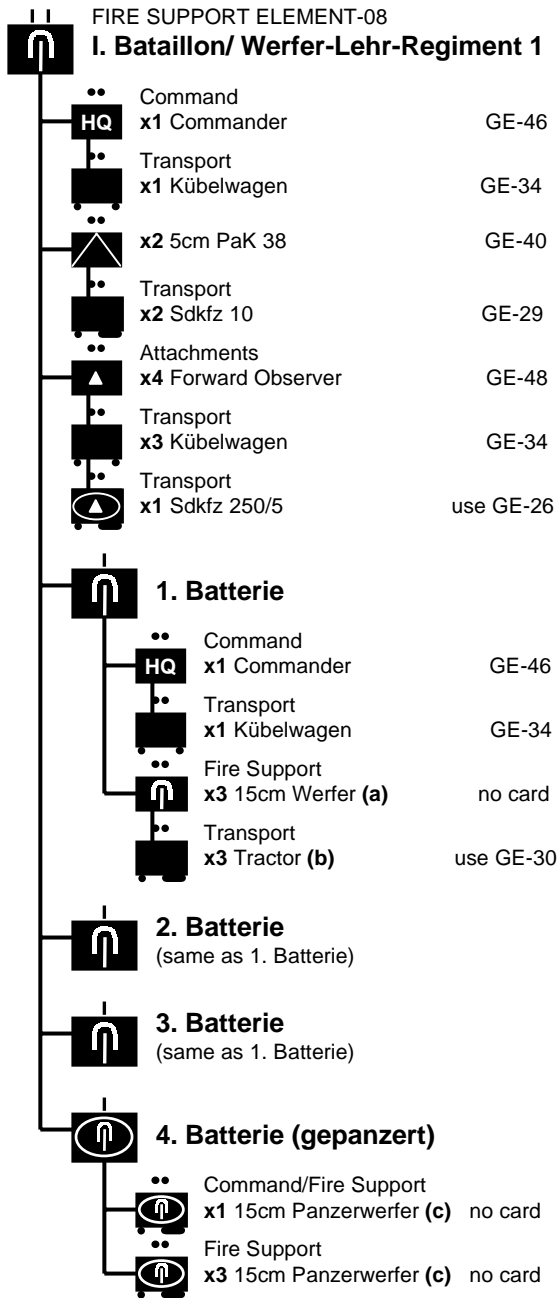

(a) The 21cm Werfer had five rockets per salvo.

(b) Tractors were usually the Opel/Ford Maultier (half-tracked trucks – use the Sdkfz 11 card as an equivalent), though a lot of French halftracks such as the Unic, Citroen-Kegresse and Somua models were also used in this role.

(a) The 15cm Werfer had six rockets per salvo.

(b) Tractors were usually the Opel/Ford Maultier (half-tracked trucks – use the Sdkfz 11 card as an equivalent), though a lot of French halftracks such as the Unic, Citroen-Kegresse and Somua models were also used in this role.

(c) The Panzerwerfer was an eight-barrelled 15cm Werfer, mounted on an 'ersatz' armoured halftrack (usually a Maultier or Somua).

# Attached Elements, II. SS-Panzer-Korps Troops (Werfer Battalion Organisations #2)

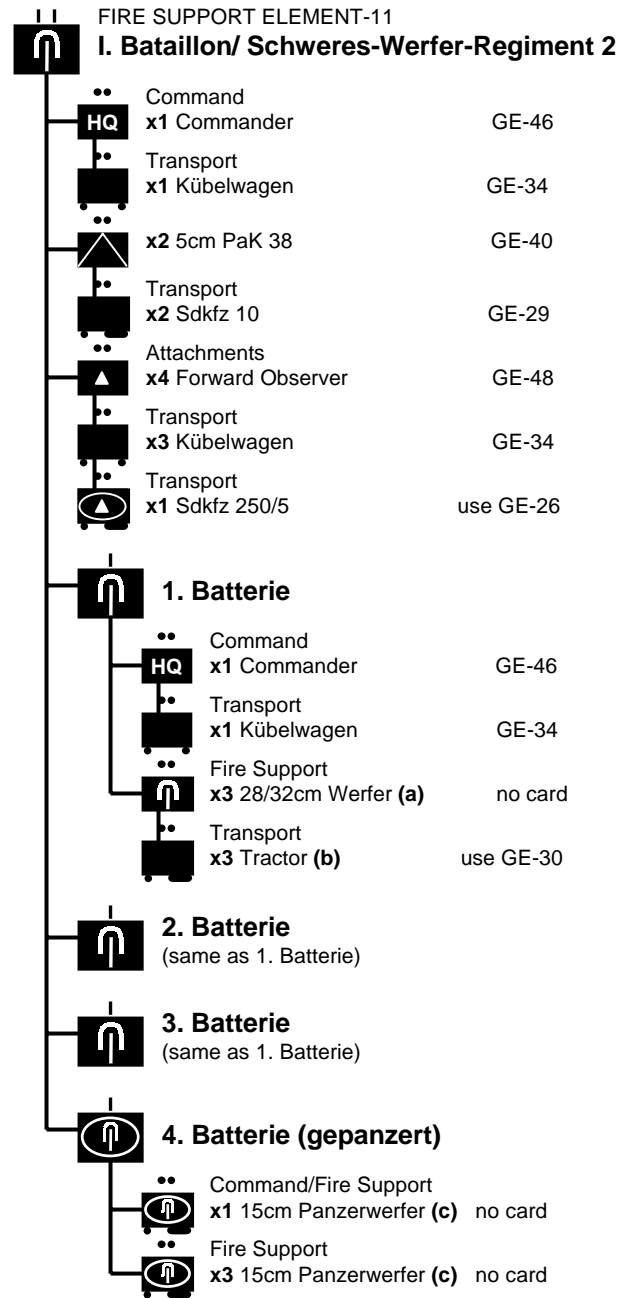
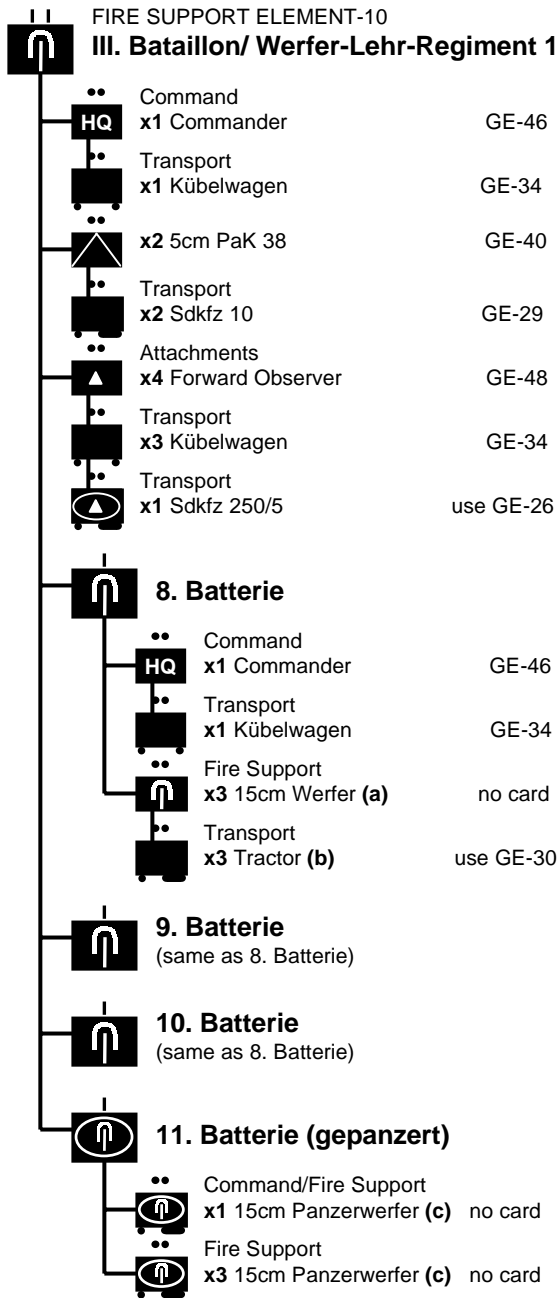

(a) The 15cm Werfer had six rockets per salvo.

(b) Tractors were usually the Opel/Ford Maultier (half-tracked trucks – use the Sdkfz 11 card as an equivalent), though a lot of French halftracks such as the Unic, Citroen-Kegresse and Somua models were also used in this role.

(c) The Panzerwerfer was an eight-barrelled 15cm Werfer, mounted on an 'ersatz' armoured halftrack (usually a Maultier or Somua).

(a) The 28/32cm Werfer had four or six rockets per salvo.

(b) Tractors were usually the Opel/Ford Maultier (half-tracked trucks – use the Sdkfz 11 card as an equivalent), though a lot of French halftracks such as the Unic, Citroen-Kegresse and Somua models were also used in this role.

(c) The Panzerwerfer was an eight-barrelled 15cm Werfer, mounted on an 'ersatz' armoured halftrack (usually a Maultier or Somua).

# Attached Elements, II. SS-Panzer-Korps Troops (Werfer Battalion Organisations #3)

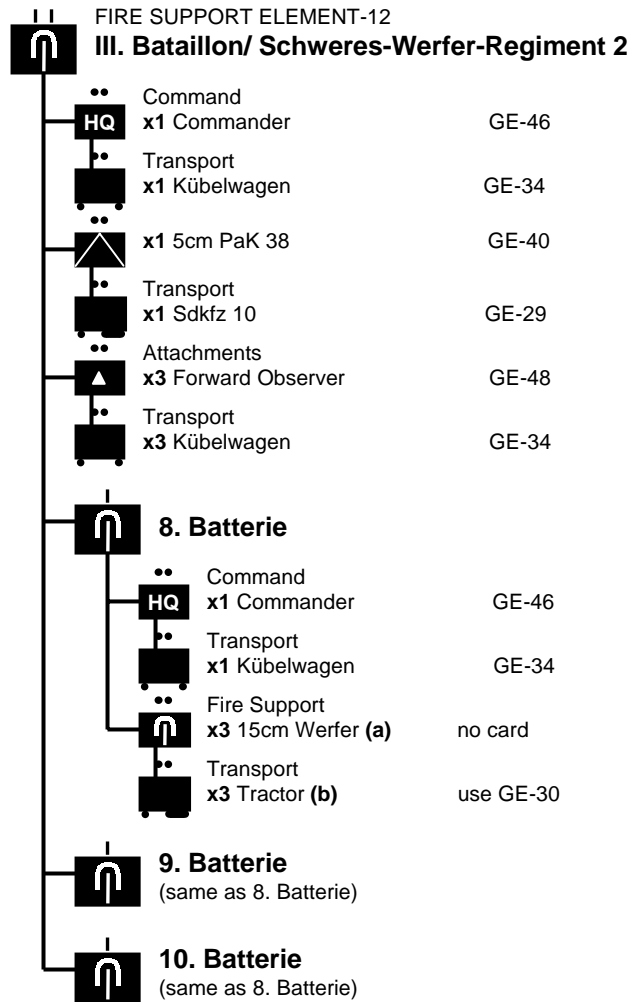
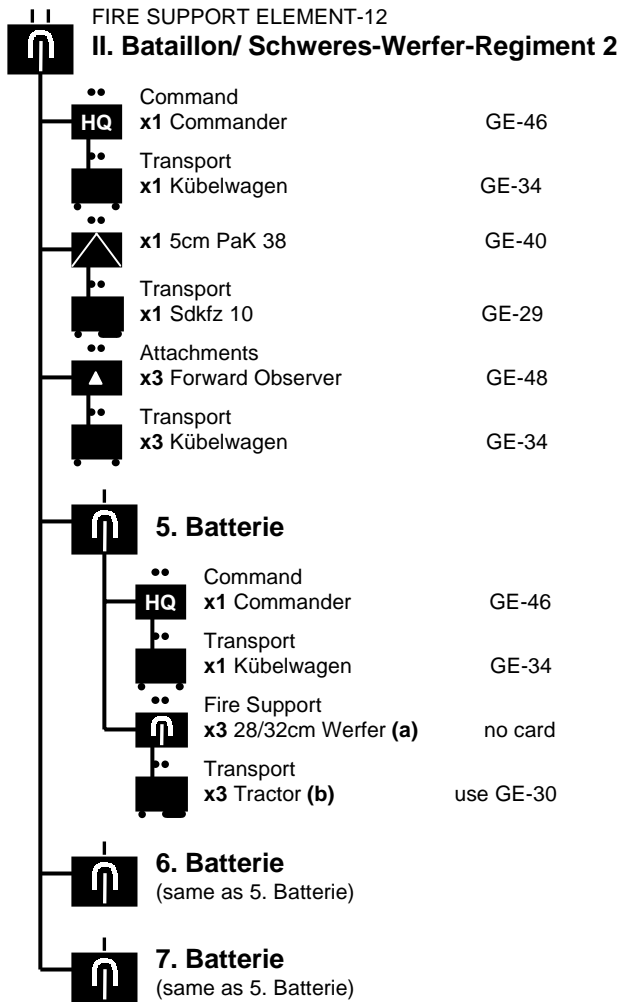

(a) The 28/32cm Werfer had four or six rockets per salvo.

(a) The 15cm Werfer had six rockets per salvo.

(b) Tractors were usually the Opel/Ford Maultier (half-tracked trucks – use the Sdkfz 11 card as an equivalent), though a lot of French halftracks such as the Unic, Citroen-Kegresse and Somua models were also used in this role.

(b) Tractors were usually the Opel/Ford Maultier (half-tracked trucks – use the Sdkfz 11 card as an equivalent), though a lot of French halftracks such as the Unic, Citroen-Kegresse and Somua models were also used in this role.

# Attached Elements, I. SS-Panzer-Korps Troops (Elements, 1. SS-Panzer-Division 'Leibstandarte SS Adolf Hitler')

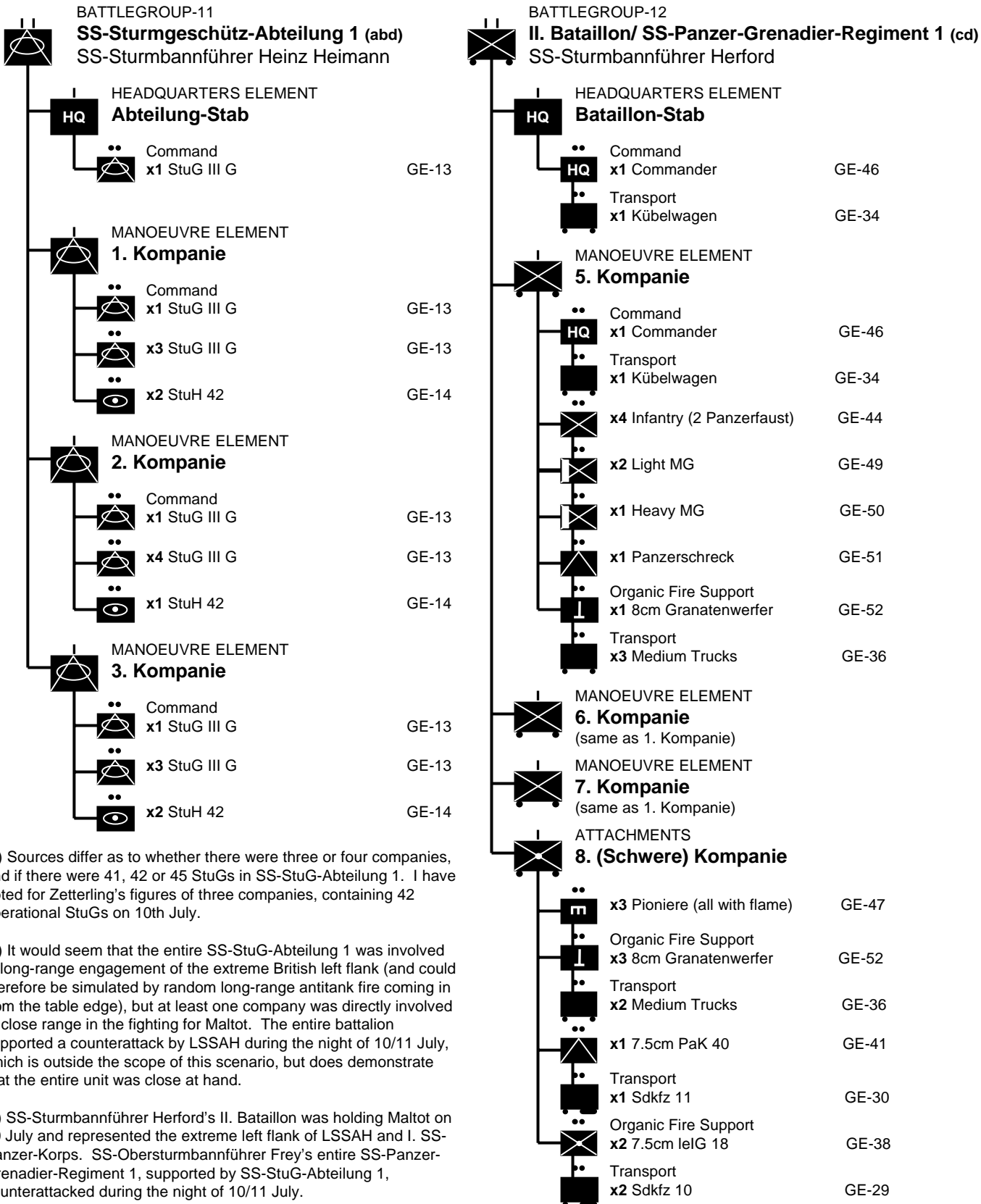

(a) Sources differ as to whether there were three or four companies, and if there were 41, 42 or 45 StuGs in SS-StuG-Abteilung 1. I have opted for Zetterling's figures of three companies, containing 42 operational StuGs on 10th July.

(b) It would seem that the entire SS-StuG-Abteilung 1 was involved in long-range engagement of the extreme British left flank (and could therefore be simulated by random long-range antitank fire coming in from the table edge), but at least one company was directly involved at close range in the fighting for Maltot. The entire battalion supported a counterattack by LSSAH during the night of 10/11 July, which is outside the scope of this scenario, but does demonstrate that the entire unit was close at hand.

(c) SS-Sturmbannführer Herford's II. Bataillon was holding Maltot on 10 July and represented the extreme left flank of LSSAH and I. SS-Panzer-Korps. SS-Obersturmbannführer Frey's entire SS-Panzer-Grenadier-Regiment 1, supported by SS-StuG-Abteilung 1, counterattacked during the night of 10/11 July.

(d) For scenario purposes, artillery observers may be attached to these units from II. SS Panzer-Korps.

# Attached Elements, I. SS-Panzer-Korps Troops (Elements, 12. SS-Panzer-Division 'Hitlerjüngend' & SS-Schweres-Panzer-Abteilung 101)

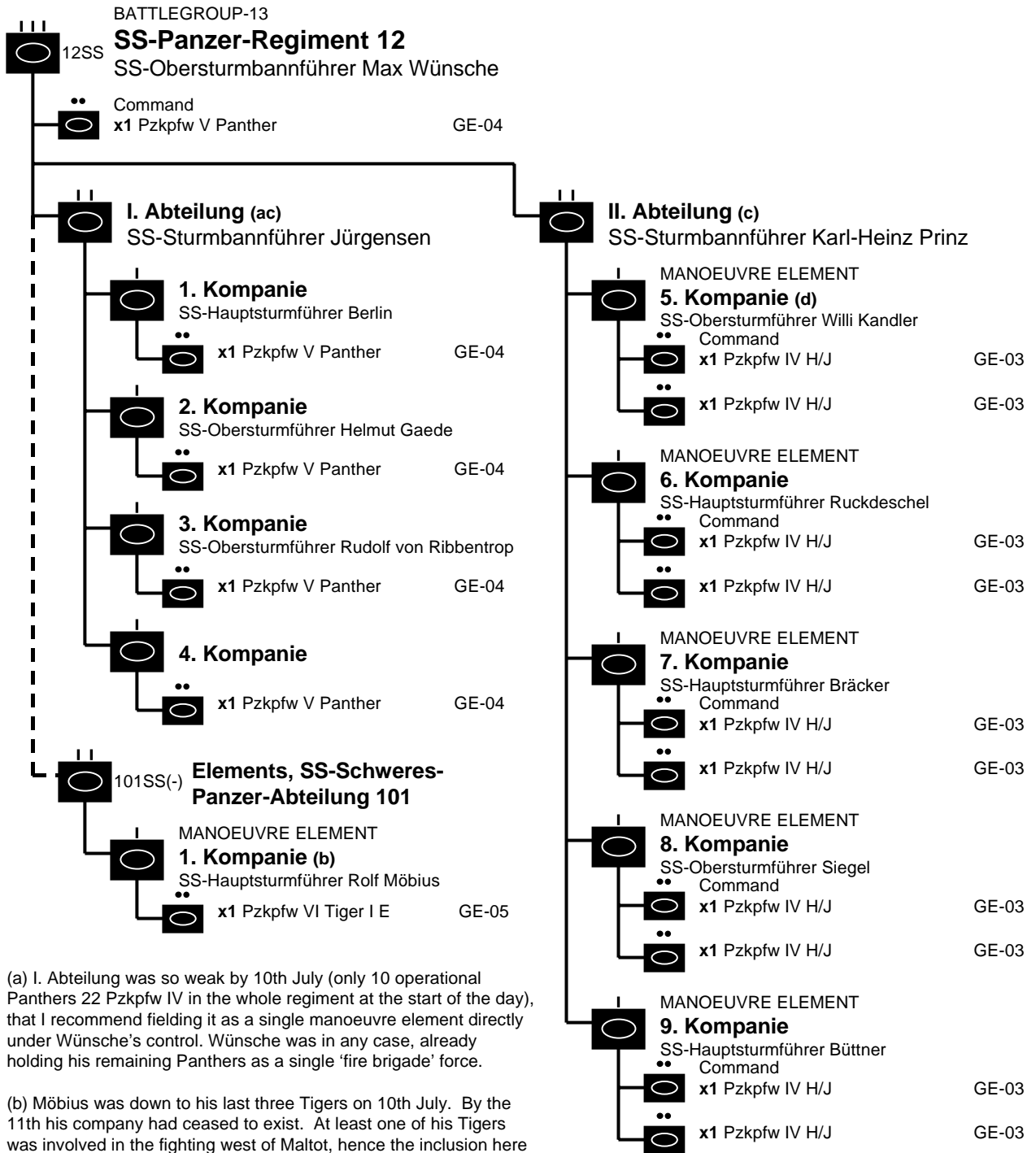

(a) I. Abteilung was so weak by 10th July (only 10 operational Panthers 22 Pzkwf IV in the whole regiment at the start of the day), that I recommend fielding it as a single manoeuvre element directly under Wünsche's control. Wünsche was in any case, already holding his remaining Panthers as a single 'fire brigade' force.

(b) Möbius was down to his last three Tigers on 10th July. By the 11th his company had ceased to exist. At least one of his Tigers was involved in the fighting west of Maltot, hence the inclusion here of a single model.

(c) Like SS-StuG-Abteilung 1, the regiment was certainly involved in long-range antitank engagements against the extreme British left flank and could be simulated by random, long-range shots from off-table. However, the British did report Panthers (though they might have been mistaken) being engaged within Maltot itself, hence the inclusion of the entire order of battle here.

(d) Kandler's 5. Kompanie was the only element of the regiment to go beyond the I. SS-Panzer-Korps' left-boundary and get involved in the fighting on the slopes of Hill 112 (along with at least one Tiger from Möbius' company). Kandler's company at least, should therefore be represented on-table - as previously mentioned, the rest of this regiment could be treated as random long-range fire from off-table.

# Attached Elements, I. SS-Panzer-Korps Troops (SS-Artillerie-Abteilung 101)

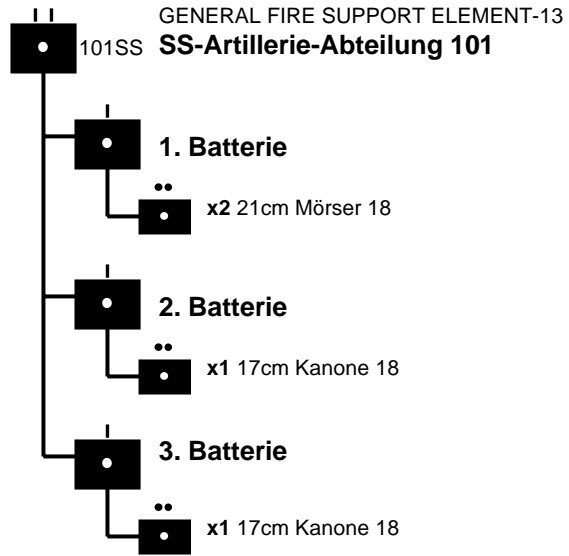



# Deployment

<b>HQ 10. SS-Panzer-Division 'Frundsberg'</b> <b>Begleit Kompanie</b>	Vieux In close support of II. Bataillon/ SS-Panzer-Grenadier-Regiment 22
<b>HQ SS-Panzer-Grenadier-Regiment 21</b> <b>II. Bataillon</b> <b>III. Bataillon</b> <b>I. Bataillon</b> <b>15. (Pionier) Kompanie</b>	Avenay Left of Esquay Between Esquay and Hill 112 Right of Hill 112 In close support of III. Bataillon
<b>HQ SS-Panzer-Grenadier-Regiment 22</b> <b>II. Bataillon</b> <b>I. Bataillon</b> <b>III. Bataillon</b> <b>15. (Pionier) Kompanie</b>	Bully Château de Fontaine Eterville Feugerolles In close support of I. Bataillon
<b>II. Abteilung/ SS-Panzer-Regiment 10</b>	Near Avenay (the tanks were soon deployed either side of Hill 112 to meet the attack)
<b>HQ SS-Panzer-Artillerie-Regiment 10</b>	Bully (the guns were apparently deployed around St. Martin and Vieux)
<b>HQ SS-Panzer-Pionier-Bataillon 10</b>	Avenay
<b>SS-Panzer-Aufklärungs-Abteilung</b>	Deployed in reserve, well to the rear. Was brought forward during the day to counter-attack at Maltot
<b>SS-FlaK-Abteilung 10</b>	Most 8.8cm batteries seem to have been deployed on or near Hill 112
<b>SS-Schweres-Panzer-Abteilung 102 (II. SS-Panzer-Korps)</b>	St. Mary (two companies soon deployed either side of Hill 112)
<b>Werfer-Brigade 8 (II. SS-Panzer-Korps)</b>	Deployed on the rear slope of Hill 112 between Gavrus and Esquay
<b>Elements, 9. SS-Panzer-Division 'Hohenstaufen'</b>	Begin arriving as reinforcements during the evening of 10th July
<b>SS-Panzer-Grenadier-Regiment 1 (LSSAH)</b>	Deployed to the right of Maltot, with II. Bataillon in Maltot itself
<b>SS-Sturmgeschütz-Abteilung 1 (LSSAH)</b>	Deployed to the right of Maltot
<b>SS-Panzer-Regiment 12 (HJ)</b>	Deployed to the right of Maltot
<b>SS-Artillerie-Abteilung 101 (I. SS-Panzer-Korps)</b>	Deployed to the rear, but within range of Hill 112
<b>Füsilier-Bataillon 277 (277. Infanterie-Division)</b>	Gavrus

# Bibliography & Sources

**Impossible Victories** – Bryan Perrett

**Hill 112 (Battles in the Odon Valley)** – Tim Saunders

**Steel Inferno (I SS Panzer Corps in Normandy)** – Michael Reynolds

**Normandy 1944 (German Military Organisation, Combat Power & Organisational Effectiveness)**  
– Niklas Zetterling

**Panzers In Normandy** – Eric Lefèvre

**The Panzers And The Battle Of Normandy** – Georges Bernage

**La Bataille de Caen** – Georges Benamou

**Hill 112 (Cornerstone of the Normandy Campaign)** – J.J. How

**10. SS-Panzer-Division 'Fruntsberg' (Normandie 1944)** – Jean-Luc Leleu

**In Ehrfurcht die Fahnen Senken** – Heinz Harmel

**SS Orders Of Battle** – M. Wood & J. Dugdale

**The German Order of Battle (Vols 1 & 3)** – George F. Nafziger

**Panzertruppen** – Thomas Jentz

## Acknowledgements

Many thanks to Mike Hickling and Bob Eldridge for their help and information.