

# Japanese Divisions & Independent Brigades In Philippines 1941-2

Formation	Commanding Generals	Infantry Regts	Artillery Regiment	Rating	Recon Element	Engineer Regiment
16 <sup>th</sup> Division	Lt Gen Morioka	9th IR 20th IR 33th IR	<u>22<sup>nd</sup> Mtn</u> 3x 75mm Bns	EXP	16 <sup>th</sup> recon	16 <sup>th</sup> Eng Regt
48th Division	Lt Gen Tsuchihashi	1 <sup>st</sup> Formosa IR 2 <sup>nd</sup> Formosa IR 47th IR	<u>48th Field</u> 3x 75mm Bns 1 x 105mm Bn	TRN	48 <sup>th</sup> recon	48th Eng Regt
56 <sup>th</sup> Division(-)		146 <sup>th</sup> IR	<u>1/56<sup>th</sup> Fd</u> 75mm Bn	EXP	56 <sup>th</sup> Inf Cmd tk coy	<u>1/56th</u>
65 <sup>th</sup> Independent Infantry Brigade	Lt Gen Nara	122 IR 141 IR 142 IR		TRN	Nil	65 <sup>th</sup> Independent Pioneer Unit

**Note:** 16<sup>th</sup> Div had one Bn of each IR mounted on bicycles. One Bn of the Arty Regt was motorised. The remainder were horsedrawn.

48<sup>th</sup> Div had one motorised, one bicycle and one foot bn in each IR. 3 of the four Arty Bns were motorised.

65<sup>th</sup> Indp Inf Bde- each IR had only 2 Bns.

**RATINGS:** 16<sup>th</sup> Div had been in China before this. 48<sup>th</sup> Div had only been raised on Formosa(Taiwan) in late 1940 and was untried in battle. The 56<sup>th</sup> Div was in North China until late Dec and could be expected to have had at least some experience there. They are rated therefore as EXP. The 65<sup>th</sup> Bde was rated by the Japanese as suitable for garrison duties, so again probably only TRN.

The 4<sup>th</sup> Tk Regt had seen action against the Russians at Nomonhan in 1939, so could be rated as VET. The 7<sup>th</sup> been part of the 2<sup>nd</sup> Armoured Group in Manchuria. It was also listed as Army reserve on the Shanghai front, so it could have seen action. I would rate it as EXP.

# Japanese Order Of Battle – The Invasion Of LUZON 1941



14th Army – Lt Gen Homma



16th Division(-)(a) – Lt Gen Morioka



48th Division – Lt Gen Tsuchihashi



65<sup>th</sup> Indp Bde – Lt Gen Nara



15<sup>th</sup> Indp Mortar Bn - **FSE-07**

(a) III/33<sup>rd</sup> IR , 16<sup>th</sup> DIV was deployed against Davao, Mindanao. Therefore 33<sup>rd</sup> IR, 16<sup>th</sup> Div is short one Bn for operations on Luzon.



4th Tank Regiment – **BG-10**



7th Tank Regiment- **BG-10**



3<sup>rd</sup> Separate Engr Regt **BGJAHK06**



21st Separate Engr Regt **BGJAHK-06**



3<sup>rd</sup> Separate Engr Coy – **ME-27**



1<sup>st</sup> FA Regt **FSE-09**



8th FA Regt **FSE-09**



9th FA Bn –**FSE-10**



3<sup>rd</sup> Rapid fire Coy –**ME-11**

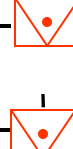

8th Rapid fire Coy - **ME-11**



9th Rapid fire Coy - **ME-11**

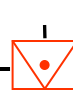

10th Rapid fire Coy - **ME-11**



45<sup>th</sup> AA Regt **BG-14**



47<sup>th</sup> AA Regt **BG-14**



48<sup>th</sup> AA Regt **BG-14**

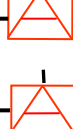

30<sup>th</sup> Separate AA Coy –**ME-29**



31<sup>st</sup> Separate AA Coy - **ME-29**

# Japanese Order Of Battle – Davao Invasion Unit 1941



## 16th Army – Lt Gen Imamura

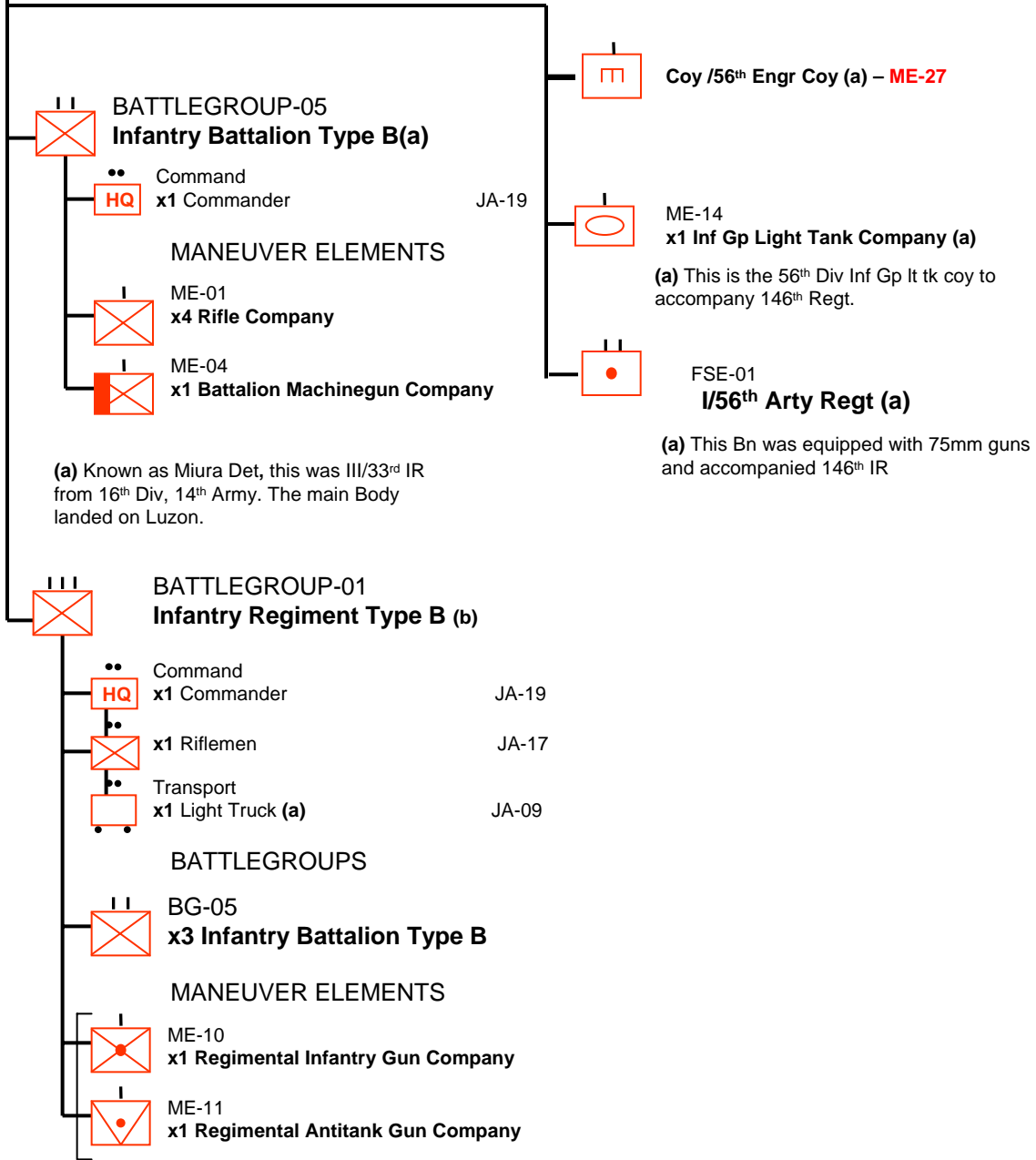

(a) The truck would be discarded in jungle or mountainous terrain. Alternatively, may exchange for:  
Mounted Infantry JA-P10

(b) Known as Sakaguchi Det, this is 146th Regt from 56th DIV, 16th Army. Attachments are to the right.

# Divisional Organisation

16<sup>th</sup> and 48<sup>th</sup> Divisions

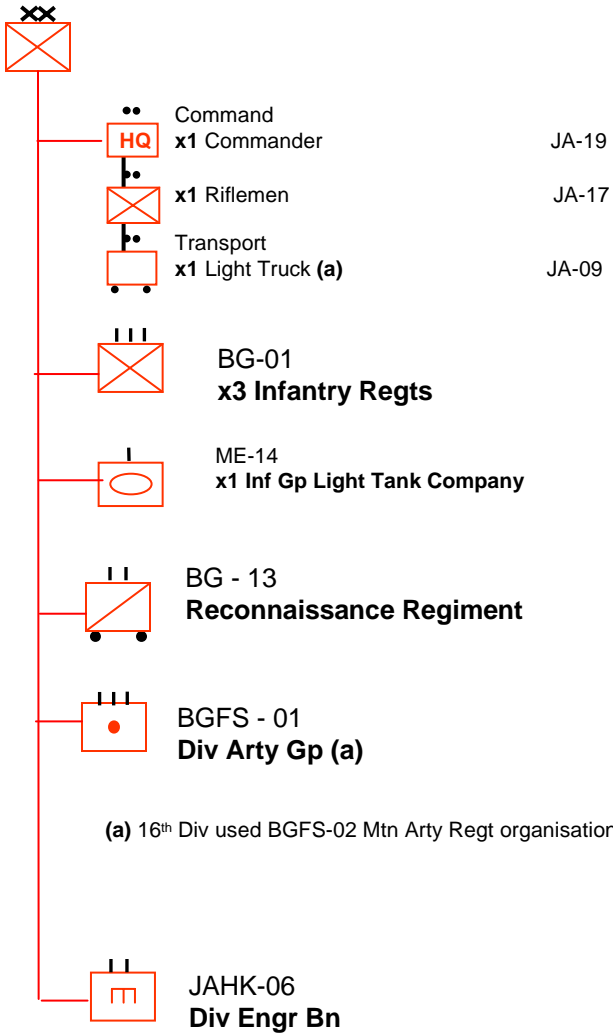

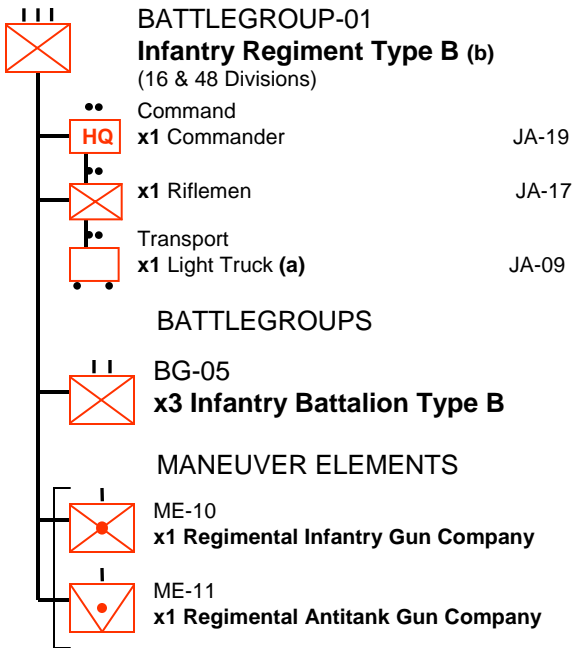

(a) The truck would be discarded in jungle or mountainous terrain. Alternatively, may exchange for:

Mounted Infantry (JA-P10)

(b) Three regiments per division.

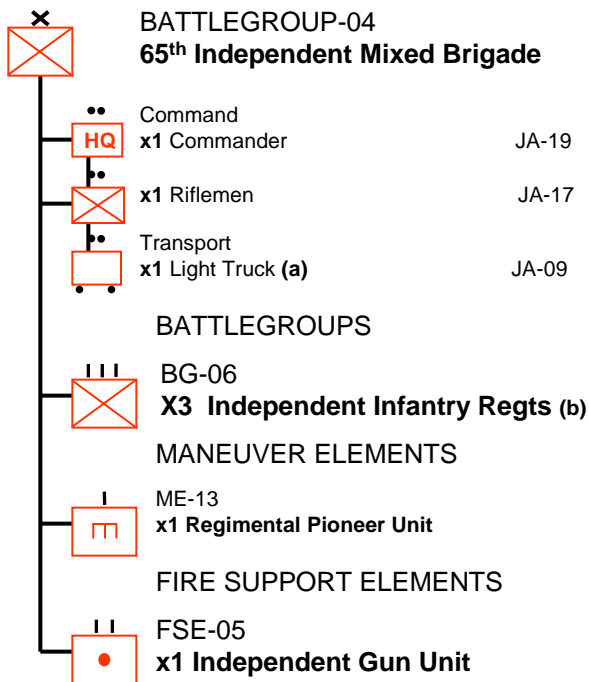

(a) The truck would be discarded in jungle or mountainous terrain. Alternatively, may exchange for:

Mounted Infantry (JA-P10)

(b) Only 2 Bns (BG-06) per regt.

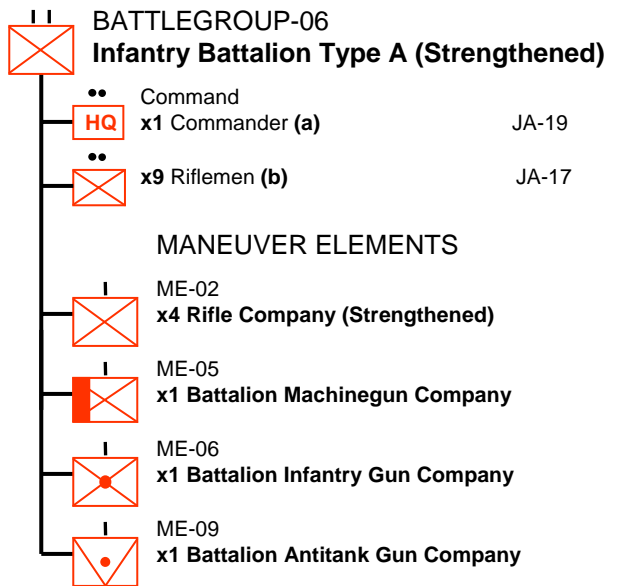
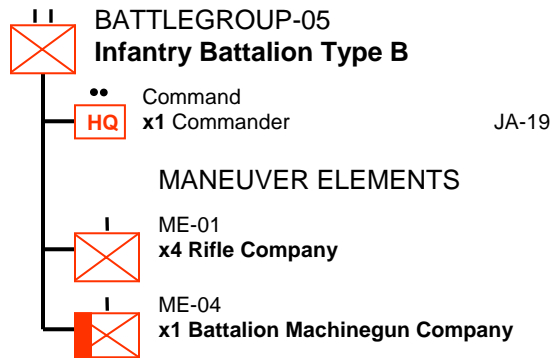

(a) May exchange for:  
 Mounted Infantry (JA-P10)

(JA-P10)

(b) The 'Strengthened' organisation had a very strong HQ defence element.

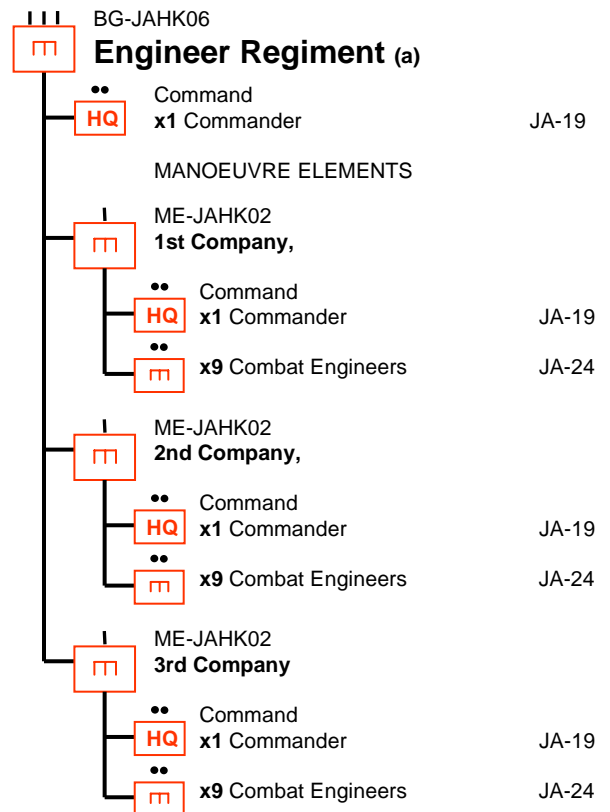
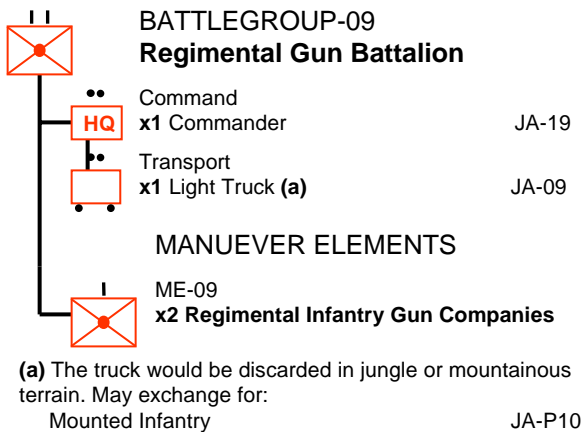
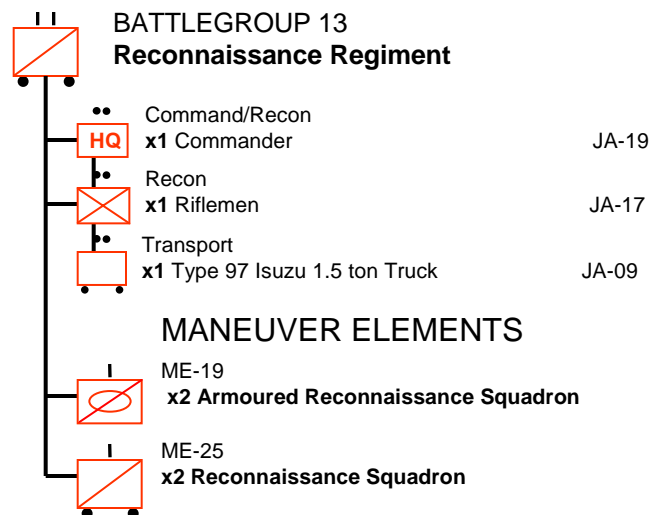
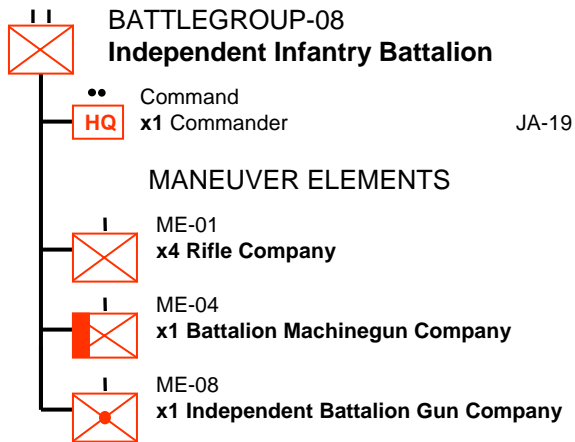

(a) Although nominally a 'regiment', Japanese Engineer Regiments were actually battalion-sized formations.

- (a) Japanese tank forces involved in the initial invasion of Philippines were equipped as follows  
**4th Tank Regt Type 95 Lt tanks- 4 lt tk coys only ME-15**  
**7th Tank Regt Type 89 Tanks- as above.**  
 (b) The 4<sup>th</sup> Tk Regt is rated as VET. It had taken part in the actions at NOMONHAN against the Russians in 1939. The 7<sup>th</sup> is rated as EXP.

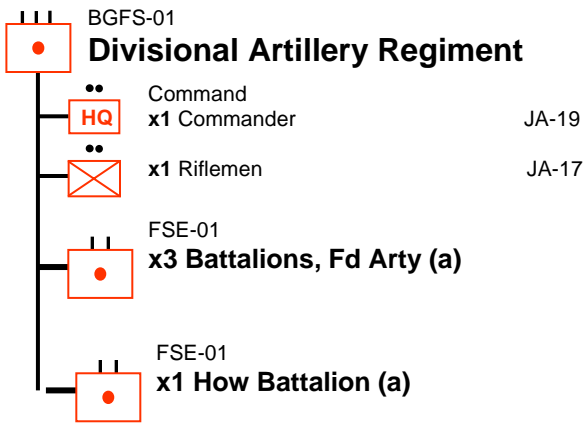

(a) 48<sup>th</sup> Div Arty had 3 Bns with 75mm guns and one with 105mm Hows.



(a) Only the 16<sup>th</sup> Div used this, with the 22<sup>nd</sup> Mtn Arty Regt.

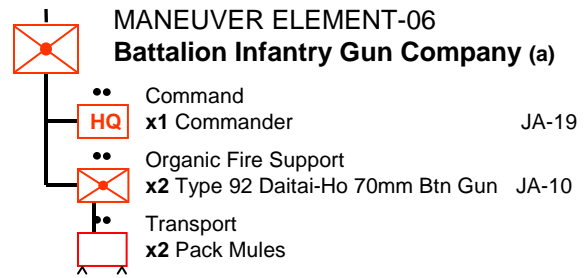
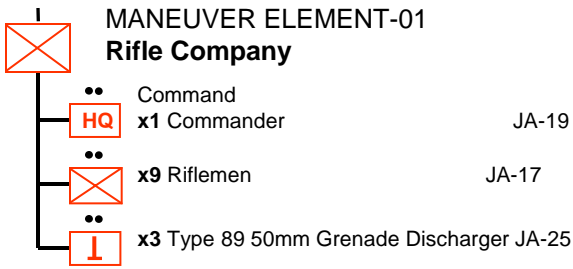

(a) The company may alternatively be split up as individual attachments to the battalion's Rifle Companies or Headquarters Element.

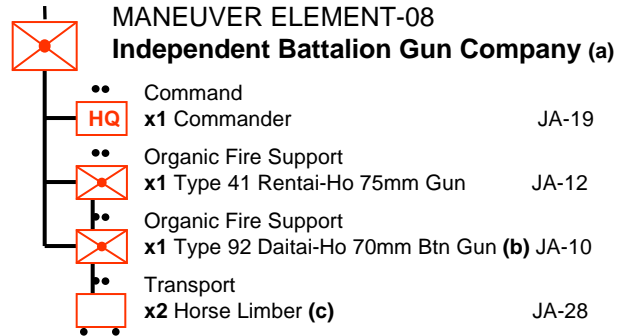
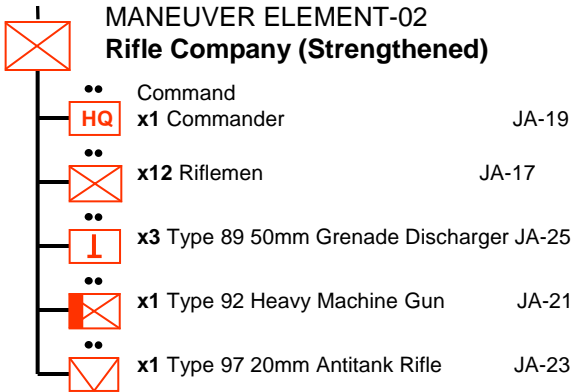

(a) The company may alternatively be split up as individual attachments to the battalion's Rifle Companies or Headquarters Element.

(b) May replace Type 92 70mm Daitai-Ho with:  
Type 94 37mm Antitank Gun JA-13

(c) May replace limbers with:  
Pack Mule

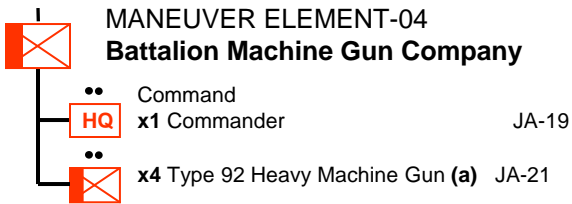

(a) Some or all HMGs in the Machine Gun Company may be directly attached to the battalion's Rifle companies.

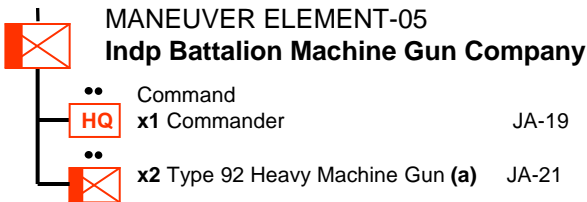

(a) Some or all HMGs in the Machine Gun Company may be directly attached to the battalion's Rifle companies.

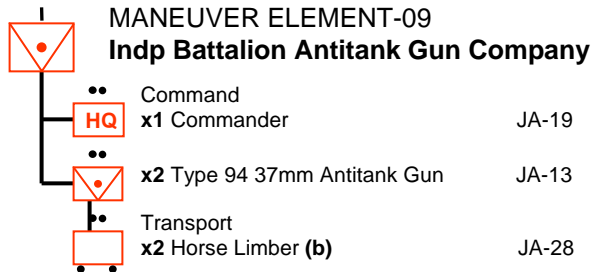

(a) The company may alternatively be split up as individual attachments to the battalion's Rifle Companies or Headquarters Element.

(b) May replace limbers with:  
Pack Mule



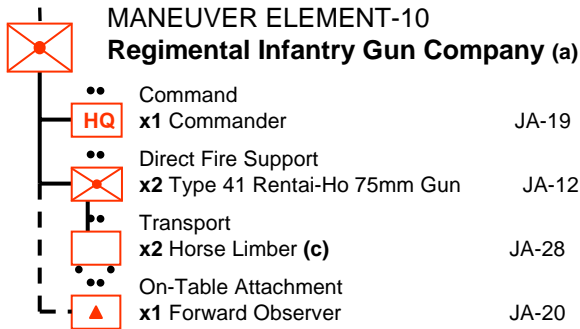

(a) The company may alternatively be split up as individual attachments to the Regiment's infantry battalions.

(c) May replace limbers with:  
Pack Mule

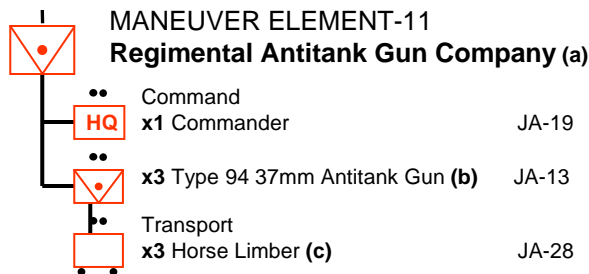

(a) The company may alternatively be split up as individual attachments to the Regiment's infantry battalions. Note that additional Antitank Companies could also be attached from Independent Antitank Regiments at army level.

(c) May replace limbers with:  
Pack Mule

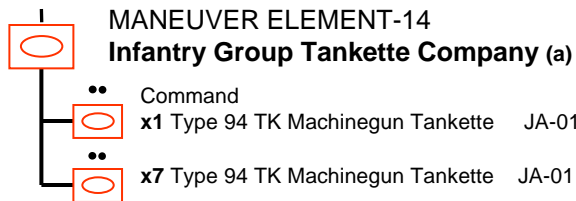
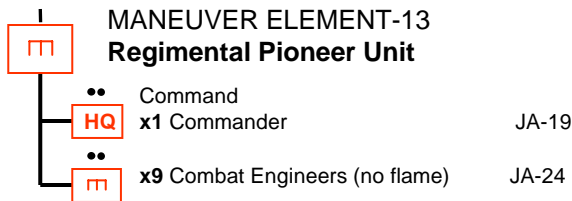

(a) The company may alternatively be split up into four platoon-sized maneuver elements, each of x2 Tankettes, as direct attachments to the division's Infantry Regiments. Designate one tank in the platoon as the commander.

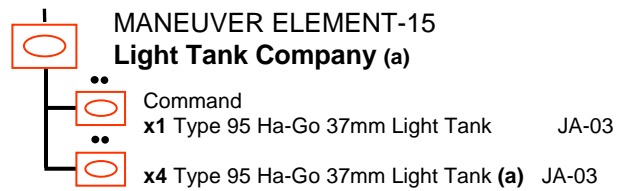

(a) The company may alternatively be split up into four platoon-sized maneuver elements, each of x1 tank, as direct attachments to BGs or MEs.

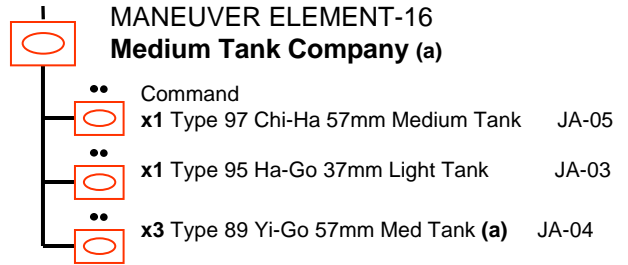

(a) The company may alternatively be split up into three platoon-sized maneuver elements, each of x1 tanks, as direct attachments to BGs or MEs.

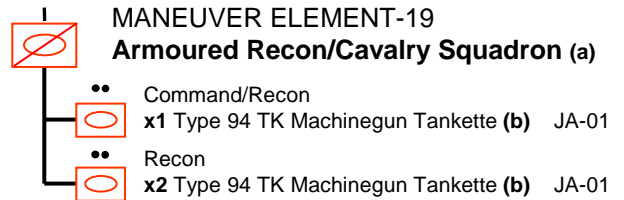

(a) The company may alternatively be split up into three platoon-sized maneuver elements, each of x1 Tankette, as direct attachments to the division's Infantry Regiments.

(b) replace all tankettes in the second squadron with:  
Type 92 Machinegun Armoured Car JA-P12

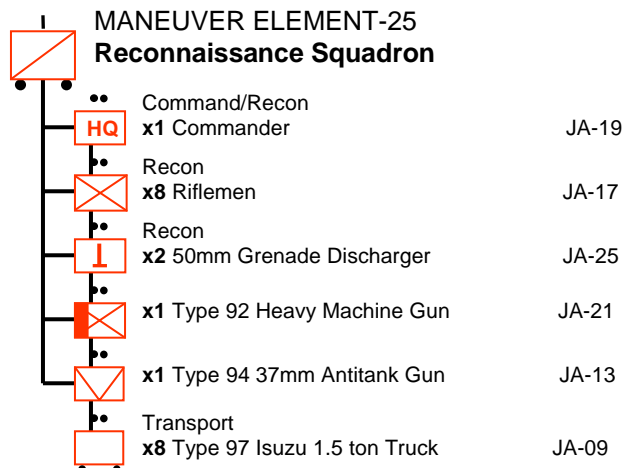

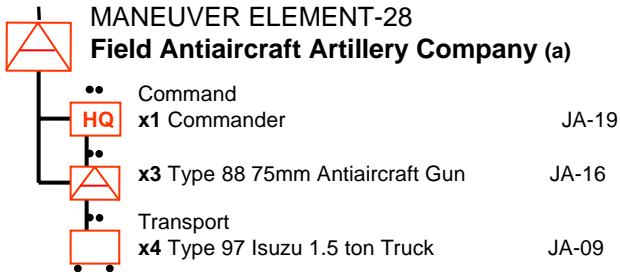
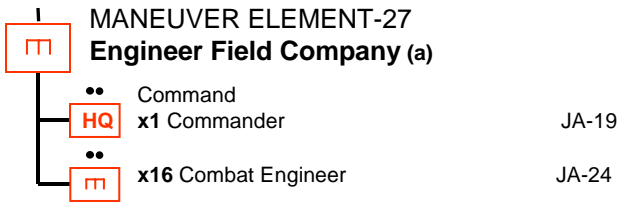

(a) Field Antiaircraft Battalions (each of three companies) and Independent Field Antiaircraft Artillery Companies were held at Army level and would be allocated down to divisions and other units.

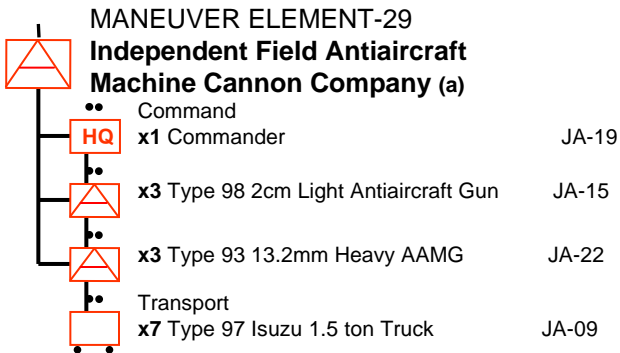

(a) Independent Field Antiaircraft Machine Cannon Companies were held at Army level and would be allocated down to divisions and other units.

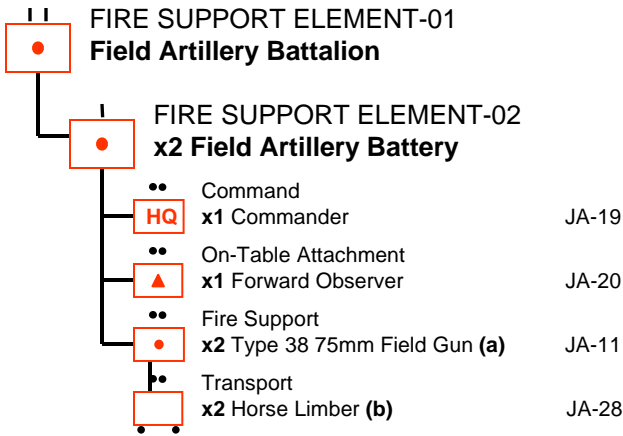

(a) In 48<sup>th</sup> Div, 3 bns were equipped with 75mm guns (JA-11) and one with 105mm How.(no card)

(b) Very few formations had motor transport for their artillery, however 48<sup>th</sup> Div had all its 75mm drawn by trucks as did one of the 16<sup>th</sup> Div arty bns. In which case, replace limbers with:  
Type 97 Isuzu 1.5 ton Truck JA-09

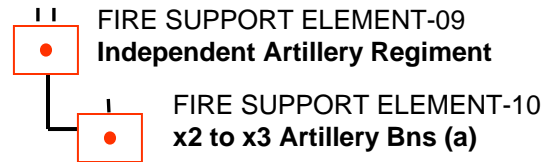
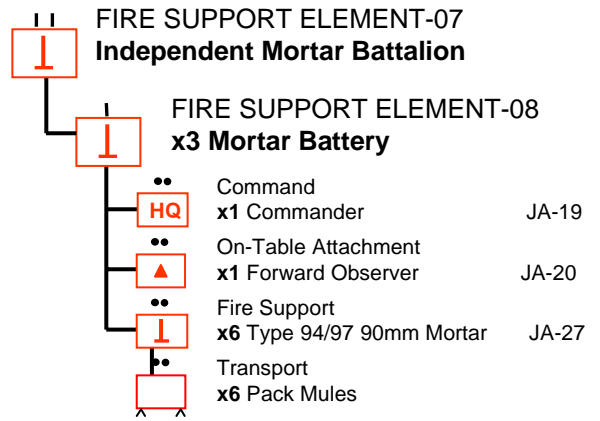

(a) Independent Artillery Regiments were Army level units. 1<sup>st</sup> Regt had 3 Bns each 2 batteries, while 8<sup>th</sup> Regt had only 2 Bns, again of 2 batteries each.

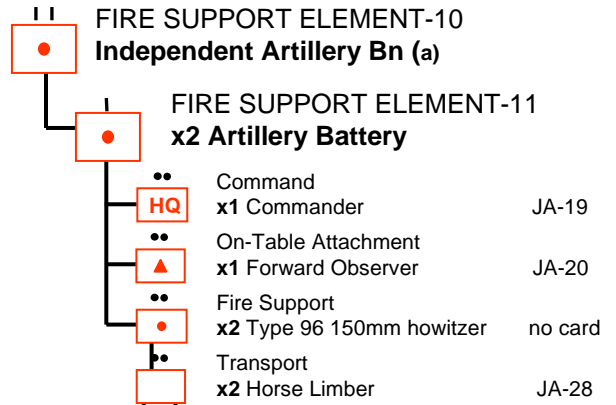
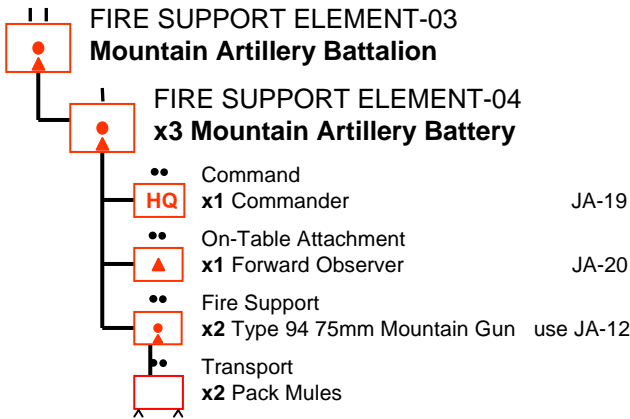

(a) 1<sup>st</sup> FA Regt and 9<sup>th</sup> FA Bn were equipped with 150mm How, 8<sup>th</sup> FA Regt had 105mm hows. (no card)

