

Philippine Islands TOEs 1941

The Philippine Islands (PI) Campaign of 1941/2 is a classic tale of unpreparedness, faulty strategy, faulty intelligence and ego overtaking rational decision-making. All this does not cause one to find fault with the soldiers of the Philippine Army. Thrown together at literally the last moment, 2/3rds of the troops had less than a month in uniform when the war came. The other third were lucky. They had had nearly three months. Some had been fortunate to fire a whole 5 rounds from the obsolete rifles provided them. The rifles were so old that the extractors were brittle and broke, forcing many troops to carry a bamboo rod to push down the barrel and force out the fired cartridge.

Low level support weapons, such as BARs, were almost non-existent, with the allocation in one division being one BAR per company, instead of the Stateside 10 per company. Machine guns were rare. Mortars non-existent, or if issued, had no ammunition for them. The few 81mm mortars were reduced to firing old 3 inch bombs over 20 years old. The artillery was a fraction of what was being used in Europe or by the Japanese. Most were old World War one British 18 pounders rebored to 75mm. Those that weren't were either 1911 colonial era pack howitzers with a very short range or the few 155mm Guns, again left over from World War One.

Given the lack of training, the lack of any martial tradition in the Philippines, the extreme shortage of everything from support weapons to uniforms, it is a wonder the Philippine troops managed to put up such a stout resistance. Let me say now that any ratings given in these TOEs are not meant to reflect on the men themselves but rather they reflect the strains and stress they were put under by such shortcomings.

These are not ORBATs as such. The whole list is an ORBAT of the Philippines. What we have here is a series of TOEs, such that ORBATs for scenarios can be put together. Hence, there are few attachments shown. These occurred throughout the course of the campaign and naturally changed over time and between battles. When scenarios are eventually produced, the forces will be drawn from these TOEs.

Scenario designers should note that the initial engagements were rather disastrous for MacArthur's strategy, with most units suffering desertion as soon as the Japanese closed. PA units should be classified as Raw in the opening battles. By the time they had withdrawn to Bataan, the faint hearted had left, leaving those who were prepared to fight. Thus discipline ratings in Bataan for the PA should be raised to Trained.

Specific notes regarding the TOEs.

Artillery

Few panoramic sights were issued but that didn't matter as there was little training in IDF. Most batteries laid by direct sight until they reached Bataan where wire was laid and the FDCs could be developed. **Therefore treat all artillery as self spotting** with the sole exception of the 155mm guns. The 155mm can deploy an FO with radio or wire and employ IDF.

Nearly all artillery was towed by being lashed by ropes and straps to the tailgates of civilian trucks. Hence, there was no rapid deployment possible.

Specific statistics are given on the suggested cards listed on the TOEs. If you wish to model the weapons, the 75mm gun was actually the WW1 UK 18pr. No model has been identified for the 2.95inch mtn how so that may have to be scratchbuilt. The M3 75mm GMC (called SPM in the PI) is available from most sources in most scales. The 155mm GPF should not appear on the table and no model is required.

Armour

The M3 Stuarts had no canister or HE rounds. Treat them as MG tanks against TGSv.

Statistics are as per the card for vs Tks.

vs. TGSv use +2/0/-2/-3 (5"/10"/20"/40")

In addition, neither the 192nd nor the 194th had fired the main gun prior to meeting the Japanese. Neither had seen the M3 Stuart until they arrived in the Philippines. Due to training and doctrine limitations, they can be classified as Raw until Bataan, when they may be upgraded to Trained.

Inf Spt weapons

Although 60mm mortars issued, there was no ammo for them. Thus they do not appear on the TOEs.

81mm Mortars had little or no ammo and were forced to use 3" Stokes mortar bombs, which had reduced ranges and defective fuses. **Use the 81mm Model for the table but use US-24 60mm mortar statistics for range and effect.**

The few LMGs and MMGs available lacked reloading facilities for their cloth belts. In some cases they were only issued two loaded belts per gun and once the belt was fired, other troops had to manually reload the belt from ammo cans. This is best reflected in Scenarios, rather than a wholesale reduction in firing abilities.

Discipline ratings

A number of sources have stated that the US and the PS units were understrength due to detachments of experienced officers and NCOs to cadre the PA units. The 31st was 1750 strong when a full strength Regt was supposed to be 2800 strong. One source says that not only were there only one officer and 10 NCOs left in each company, but that two thirds of the enlisted men were draftees sent to the Philippines for basic training. On this basis, I would suggest the US and PS units all be regarded as starting the campaign as Trained. By Bataan, they could be raised to experienced.

Even the best efforts of a number of authors cannot conceal the fact that the PA soldier lacked even basic training and the large number of desertions on the retreat to Bataan lend weight to a rating of Raw.

ARTILLERY ORGANISATION

unit	1st Bn			2nd Bn		3rd bn	
	A Btty	B Btty	C Btty	A Btty	B Btty	A Btty	B Btty
1/86th FA	c/a*	c	c				
88th Regt	a	a		a	a	a	a
1/23rd	a	b	a				
24th FA	a	a		a	a	b	b
301st	c	c		c	c	c	c
11th	a	a		b	b	a	a
21st	a	a		a	a	a	a
31st	a	a		d	d	d	d
41st	a	a		a	a	b	d
51st	a	a		d	d	d	d
61st	d	d		d	d	d	d
71st	a	a		a	a	b	b
81st	d	d		d	d	d	d
91st	b	b		d	d	d	d
101st	d	d		d	d	d	d
a	x2 75mm models						
b	x2 2.95 inch models						
c	x2 155mm GPF models						
d	Sources suggest organised as Inf -Use PIBG-08						
*Some suggest 1/86th had a Btty with 75mm, hence the possibility of a.							
Those with 3 bns had only 2 btty's per bn incl 1st Bn..							

USAFFE

X X X X

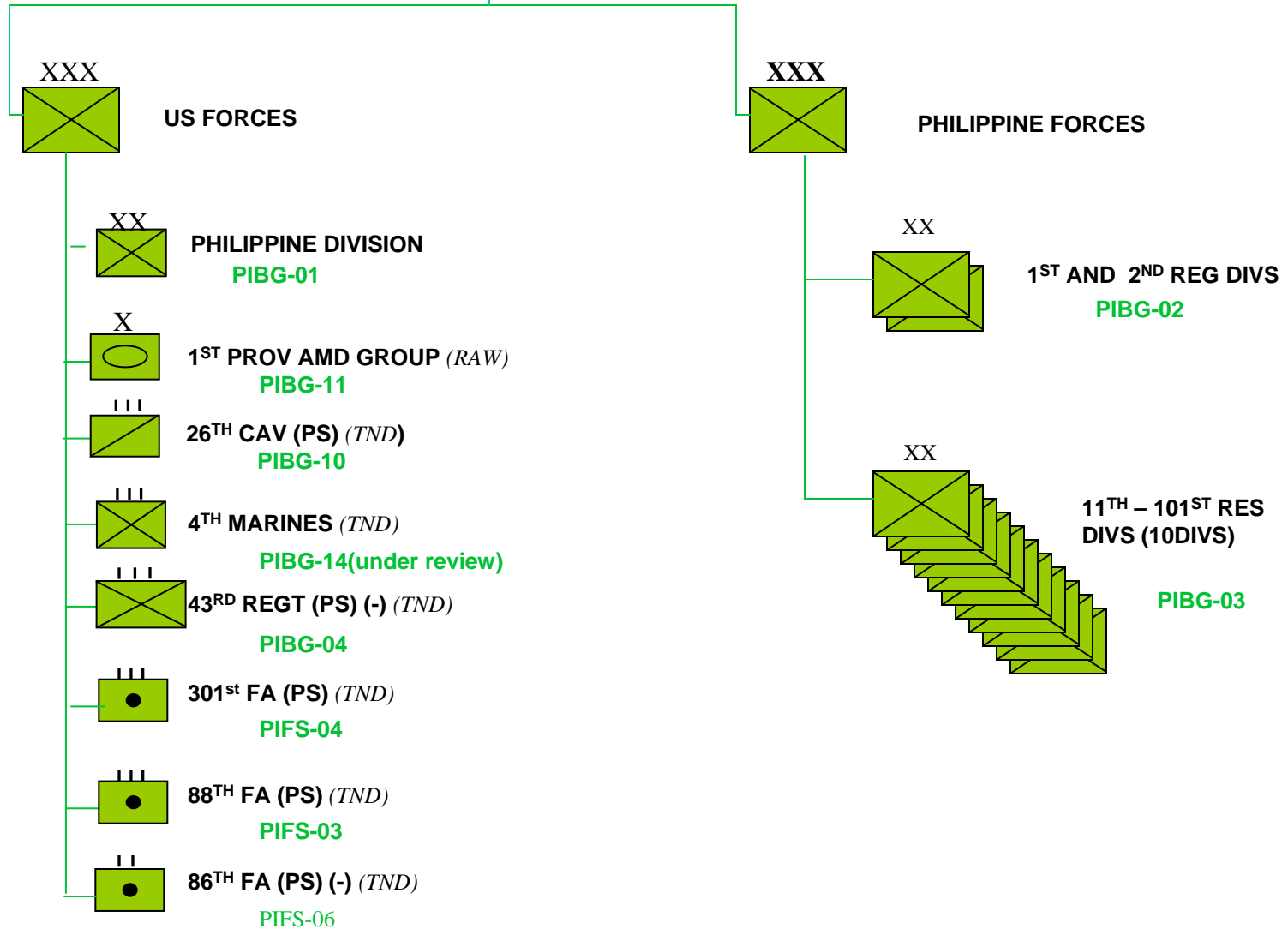

PI BG-01->BG-03

PIBattle Group-01 Philippine Division US ARMY (TND)

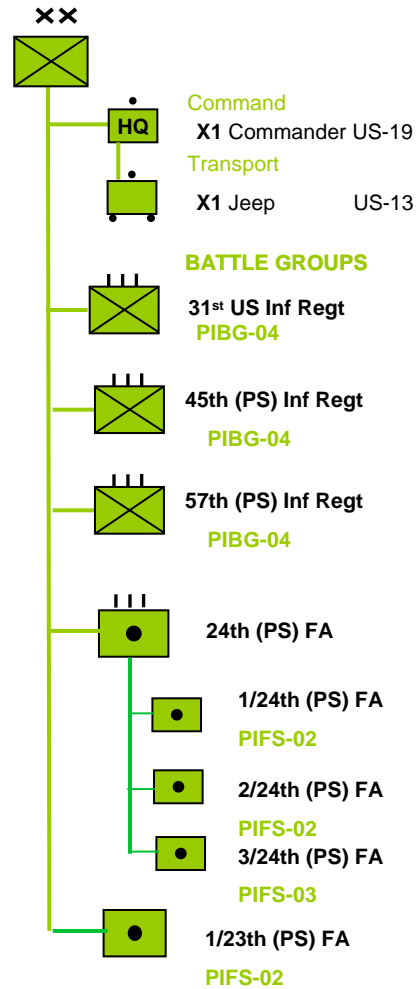

PIBattle Group-02 Regular Divisions Philippine Army (RAW)

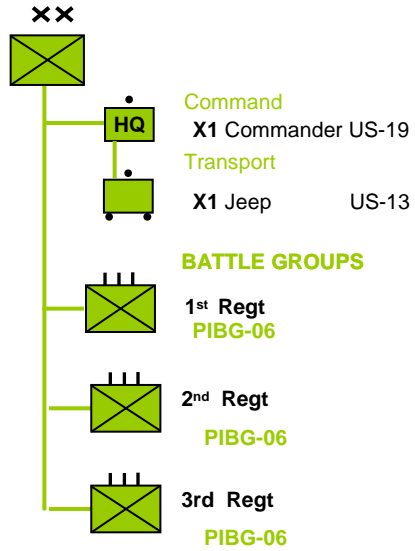

Note 1: 1st Reg Div, PA had Reg Inf Regts, while 2nd Div had PC Regts. There seems little difference between them

Note 2: No Artillery was on the establishment. Some were attached once the divisions reached Bataan.

PIBattle Group-03 Reserve divisions 11-101 Philippine Army (RAW)

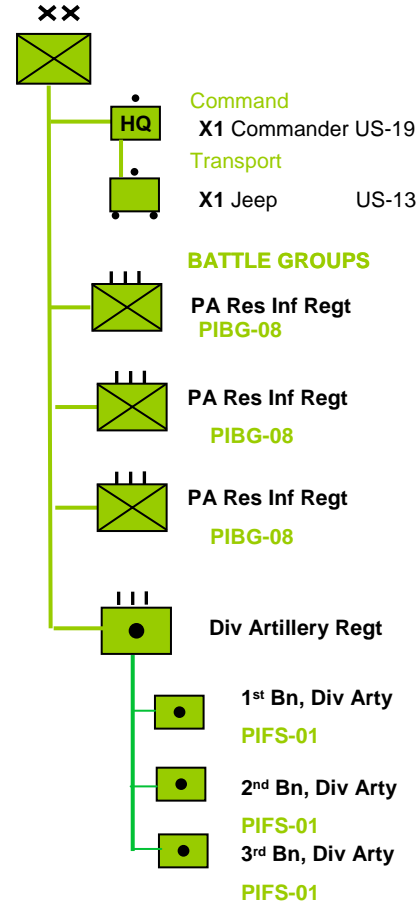

Note: Not all PA Res Divs had the full complement of artillery. See Initial notes for artillery strengths of each Division.

PIBG-04
US/PS Infantry Regiment

PI BG-04->05

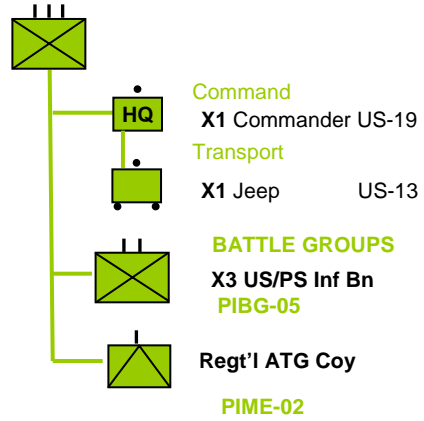

PIME-02
US/PS Regt'l ATG Coy

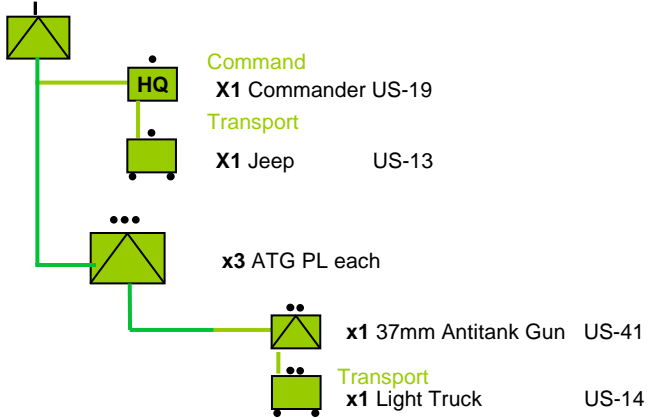

PIBG-05
US/PS Infantry Battalion

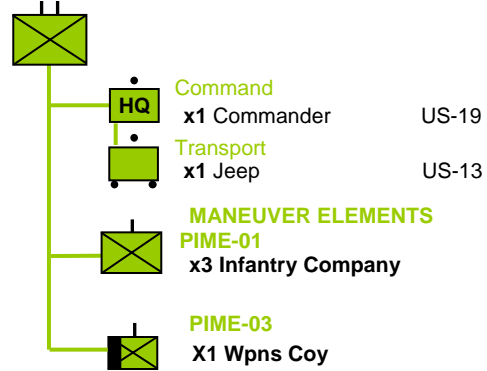

PIBG 06-09

PIBG-06

PA Reg Infantry Regiment

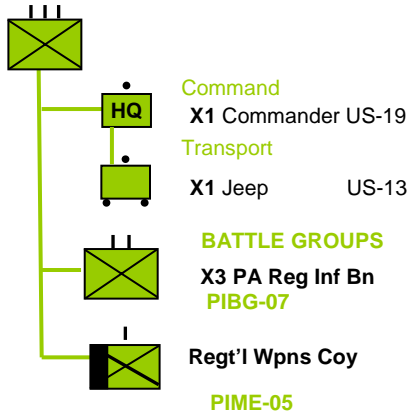

PIBG-08

Res PA Infantry Regiment

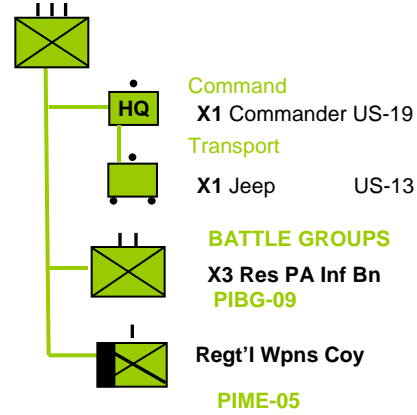

PIBG-07

PA Reg Infantry Battalion

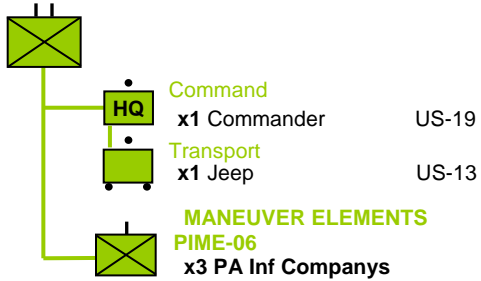

PIBG-09

Res PA Infantry Battalion

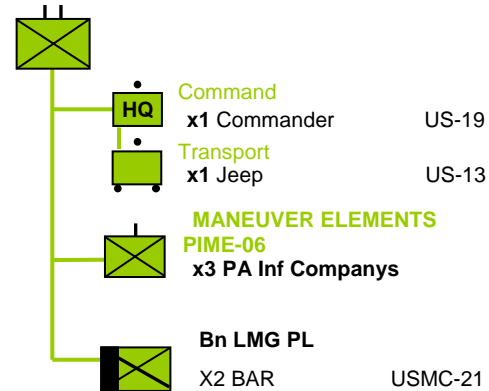

PIBG-10 > -12

PIBG- 10

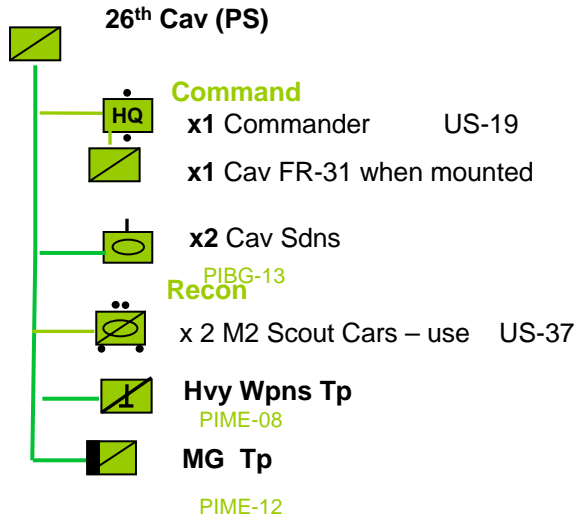

PIBG- 12

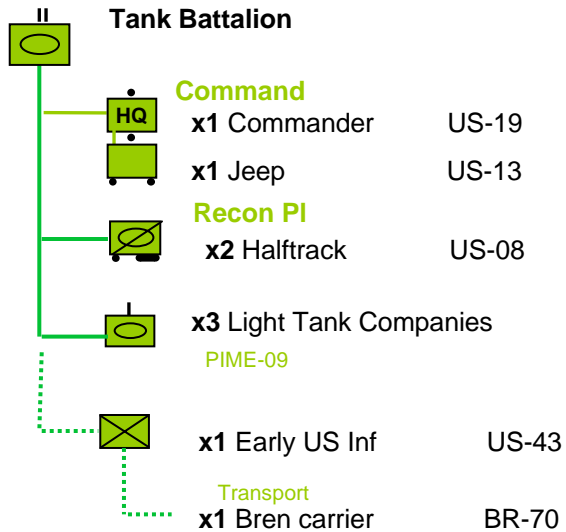

PIBG- 11

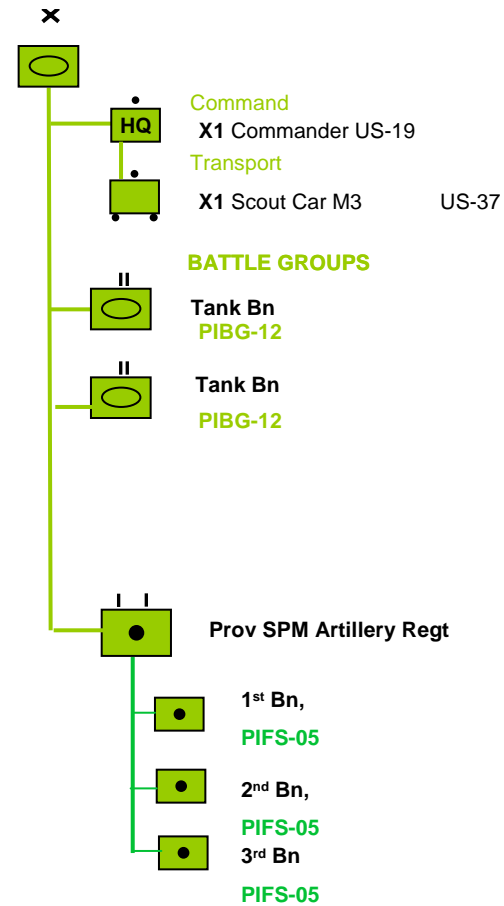

Note: Two Bns were on North Luzon and the third was attached to South Luzon Force.

PIBG-13

PIBG-13

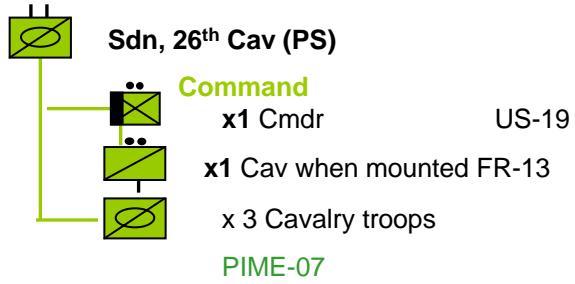

PI ME-01->ME-06

PIME- 01

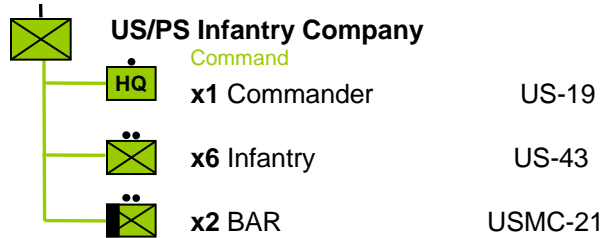

Note 1: All references suggest both the US and the PS Inf Regts were well understrength due to detachments to man the PA Reserve Divisions.

Note 2: US org infantry still had three squads of riflemen and one squad of 2 BARs per platoon. This was not officially changed until April 1942. Thus, this organisation reflects the separation of BARs from the rifle squads.

PIME- 03

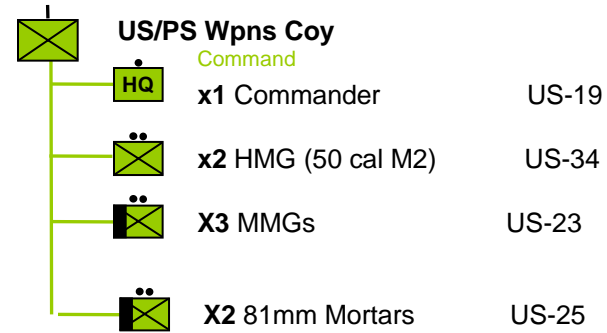

PIME- 06

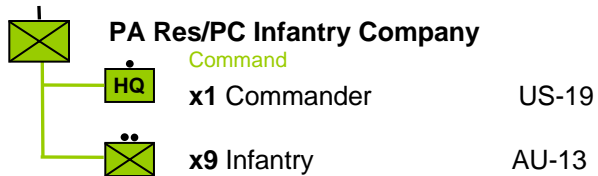

PIME- 05



PI ME-07->PIME-12

PIME- 07

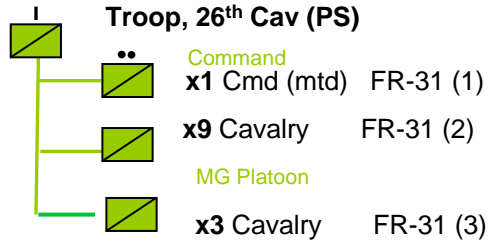

Note 1: Replace with US-19 Cmd when dismounted.

Note 2:; Replace with US-43 when dismounted.

Note 3; replace with LMG (M1919A4) US- 22

PIME- 08

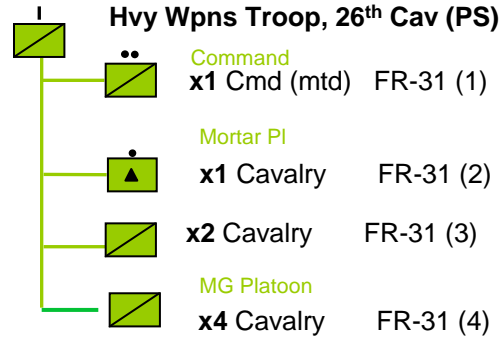

Note 1: Replace with US-19 Cmd when dismounted.

Note 2: Replace with Forward Observer US-21 when dismounted

Note 3: Replace with 81mm Mortar US-25 when dismounted.

Note43: replace with HMG M2 .50cal US -34 when dismounted

PIME- 09

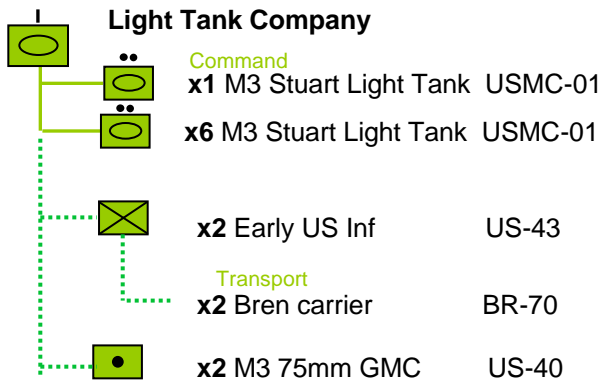

Note: The use of the M3 75mm GMC on table was not usual as these normally acted as the IDF unit for the Lt Tk Coy.

PIME- 12

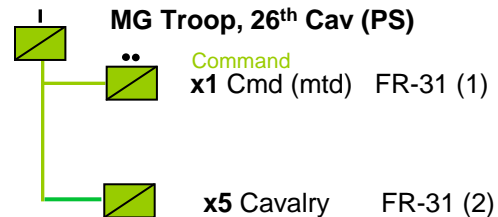

Note 1: Replace with US-19 Cmd when dismounted.

Note 2: Replace with US-23 when dismounted

PI FS-01->-06

PIFS-04

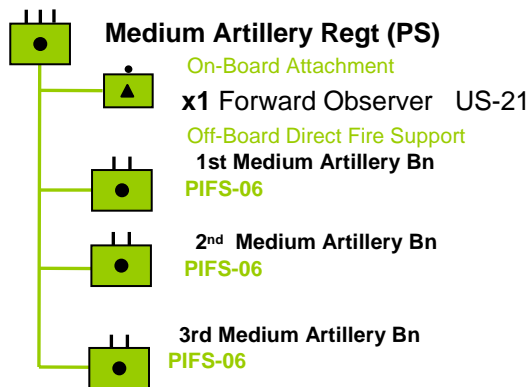

PIFS-01

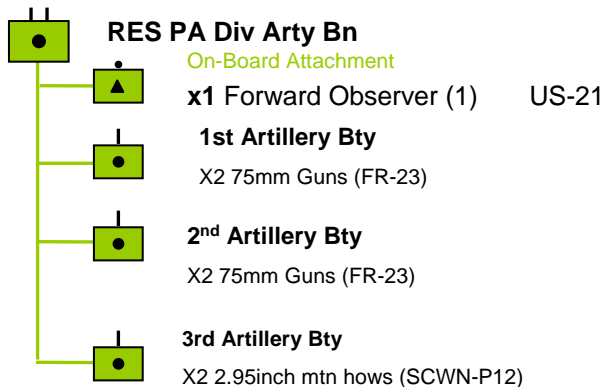

Note 1: Only 1 FO per Bn max. Most Bns did not even have this luxury and operated in self spotting mode. See Arty Notes.

PIFS-02

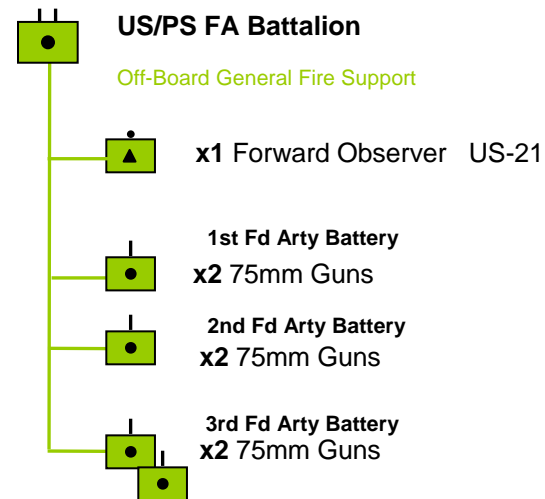

PIFS-06

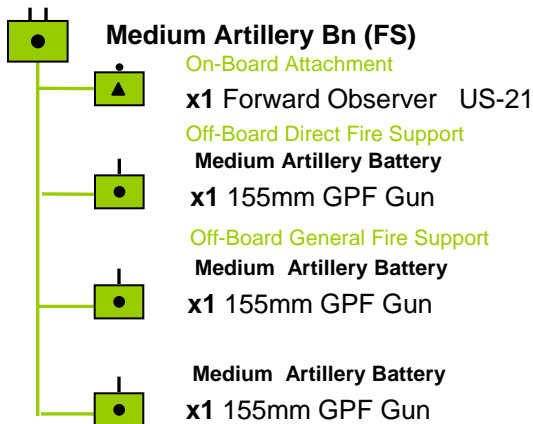

Note: 86th FA (PS) commenced with only one Bn. After the conversion of the CA 155mm GPF to Mdm Spt, they expanded to 2 Bns only.

PIFS-05

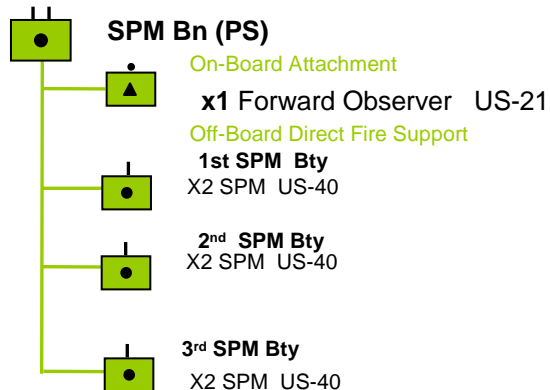

Note: These may be deployed on table in support of the Ind Tk Bns. These acted as AT support. See PIME-09

PIFS-03

