

Russian Mechanized Corp Composition 1942-1945

In September 1942 a Mechanized Corp consisted of the following:

- Corps HQ
- 3 Mechanized Brigades BG-20
- 1 Tank Brigade BG-37 or
- 2 Tank Regiments BG-22 or
- 2 Tank Brigades BG-37
- Guards Mortar Battalion BG-15
- Motorcycle Battalion BG-31
- Armored Car Battalion BG-32
- Engineer Company ME-11

In January 1943 add the following:

- Mortar Regiment FS-21
- SU Regiment (Mixed) BG-24

In February 1943 change the following:

- Expand the Engineer Company to an Engineer Battalion BG-33

In March 1943 add the following:

- Antiaircraft Regiment BG-29

In April 1943 add the following:

- Antitank Regiment BG-30

In May 1943 add the following:

- (Separate) Antitank Battalion BG-34

In August 1943 add, change or remove the following:

Add:

- SU Regiment (SU76) BG-25
- SU Regiment (SU-85) BG-26

Change:

- Antitank Regiment BG-30 – replace 45mm guns with 76,2mm guns

Remove:

- (Separate) Antitank Battalion BG-34
- SU Regiment (Mixed) BG-24

Final Mechanized Corp TOE:

- Corps HQ
- 3 Mechanized Brigades BG-20
- 1 Tank Brigade BG-38
- 1 Heavy SU Regiment BG-27
 - or 1 Heavy Tank Regiment BG-39
- 1 Medium SU Regiment BG-28
- 1 Light SU Regiment BG-25
- 1 Antiaircraft Regiment BG-29
- 1 Mortar Regiment FS-11
- 1 Guards Mortar Regiment FS-15
- 1 Armored Reconnaissance Battalion BG-11
 - or Motorcycle Battalion BG-31
- 1 Engineer Battalion BG-33

Russian Tank Corp Composition 1942-1945

In late March 1942 a Tank Corp consisted of the following:

Corps HQ
3 Medium Tank Brigades BG-37
Motorized Rifle Brigade BG-41
Engineer Company ME-11
Reconnaissance Company BG-40

In May 1942 a Tank Corp consisted of the following:

Corps HQ
2 Medium Tank Brigades BG-37
Heavy Tank Brigade BG-35, (Replace in July by a third Medium Tank Brigade)
Motorized Rifle Brigade BG-41
Antiaircraft Battalion BG-23
Guards Mortar Battalion FS-15
Motorcycle Battalion BG-31
Engineer Company ME-11

In January 1943 add the following:

Mortar Regiment FS-21
SU Regiment (Mixed) BG-24

In February 1943 change the following:

Expand the Engineer Company to an Engineer Battalion BG-33

In March 1943 add the following:

Antiaircraft Regiment BG-29

In April 1943 add the following:

Antitank Regiment BG-30
(Separate) Antitank Battalion BG-34

In August 1943 add, change or remove the following:

Add:

Heavy SU Regiment (SU152) BG-27
SU Regiment (SU-85) BG-26

Remove:

(Separate) Antitank Battalion BG-34
Antitank Regiment BG-30

In August 1944 add the following:

Light Artillery Regiment (Mtz) FS-16

Final Tank Corp TOE:

Corps HQ
3 Medium Tank Brigades BG-38
1 Motorized Rifle Brigade BG-41
1 Heavy SU Regiment BG-27
or 1 Heavy Tank Regiment BG-39
1 Medium SU Regiment BG-28
1 Light SU Regiment BG-25
1 Light Artillery Regiment FS-16
1 Antiaircraft Regiment BG-29
1 Mortar Regiment FS-11
1 Guards Mortar Regiment FS-15
1 Armored Reconnaissance Battalion BG-11
or Motorcycle Battalion BG-31
1 Engineer Battalion BG-33

Battle Group-20

Mechanized Brigade Sept. 1942 – May 1945

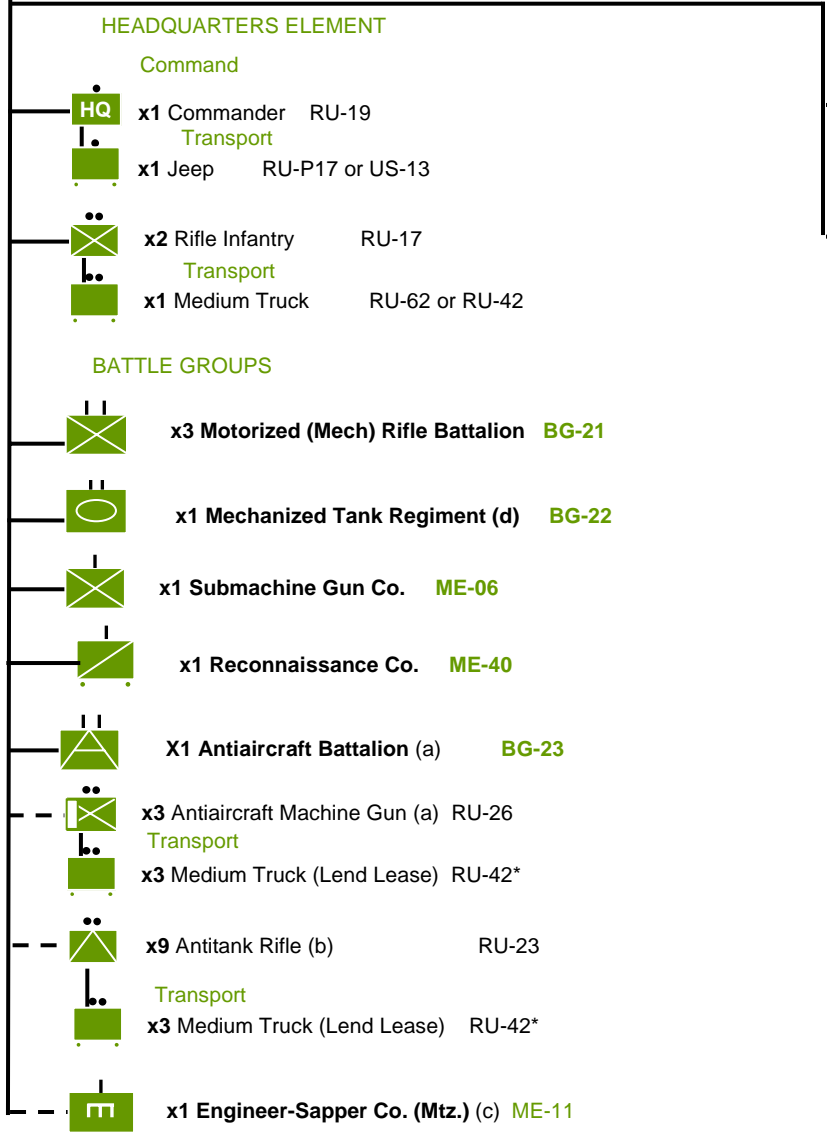

FIRE SUPPORT ELEMENTS

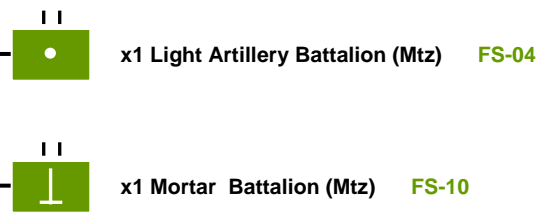

- (a) In February 1943, replace the Antiaircraft Battalion with Antiaircraft Machinegun Company
- (b) In February 1943, add a Antitank Rifle Company.
- (c) In February 1943, add Engineer Company ME-11.
- (d) In April 1944 replace Mechanized Tank Regiment BG-22 with **Mechanized Tank Regiment BG-35**

Battle Group-21

Motorized (Mech) Rifle Battalion Sept 42 – May 1945

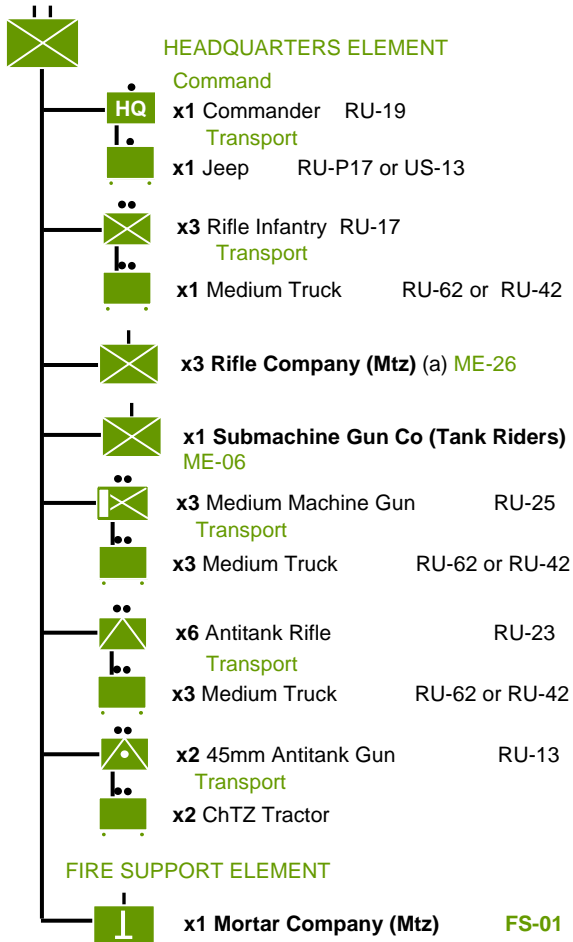

(a) In April 1943 replace ME-26 with ME-04

Battle Group-22

Separate Tank Regiment July 1942 – May 1945

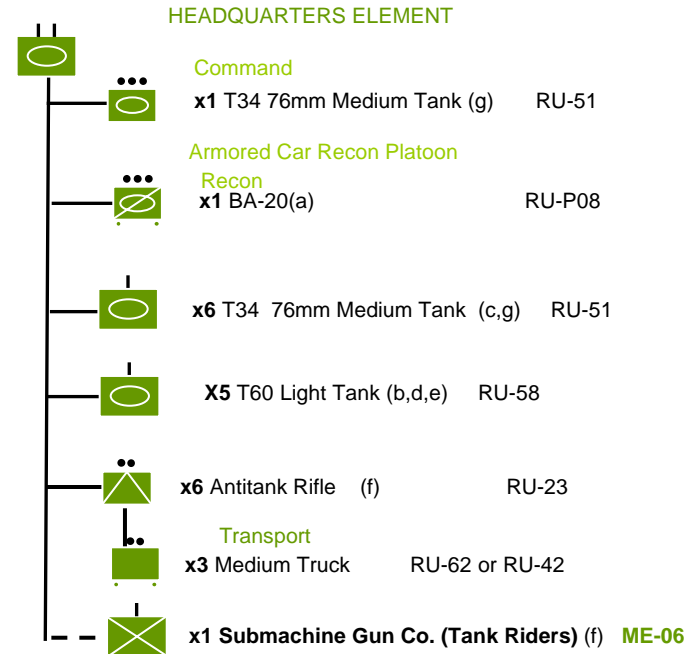

(a) May replace with BA-10 - RU-61 or BA-64B - RU-10

(b) May replace with T-70 - RU-01, M3 Stuart – RU-37, Valentine – RU-33, or Matilda II – BR-69

(c) In January 1943, increase the total number of Medium Tanks to 9.

(d) In January 1943 decrease the number of light tanks to 3.

(e) In February 1944 remove the Light Tank Company.

(f) In February replace the Antitank Rifle Company with Submachine Company.

(g) May replace T34/76 with:

Early '43: T34/43	RU-02
Mid '44: T34/85	RU-03
Early '44: M4(76)	RU-36

Battle Group-23

Antiaircraft Battalion March 42

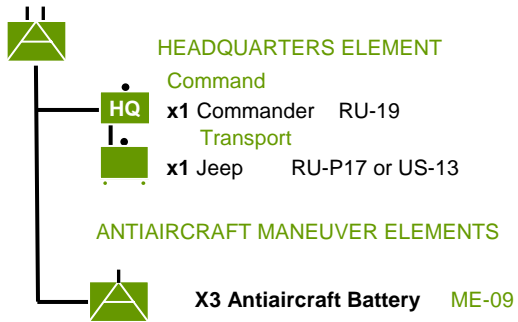

Battle Group 25

Light SU Regiment April 1943

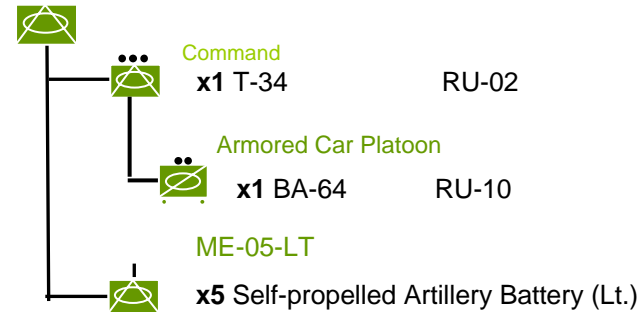

Battle Group 24

(Mixed) SU Regiment Jan, 1943



Battle Group 26

Medium SU Regiment April 1943

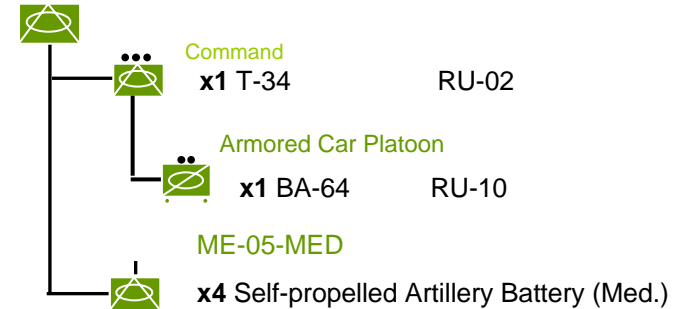

Battle Group 27

Heavy SU Regiment August 1943

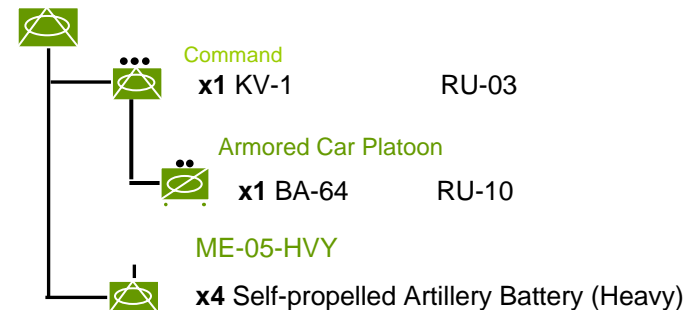

Battle Group 28

SU Regiment February 1944 – May 1945

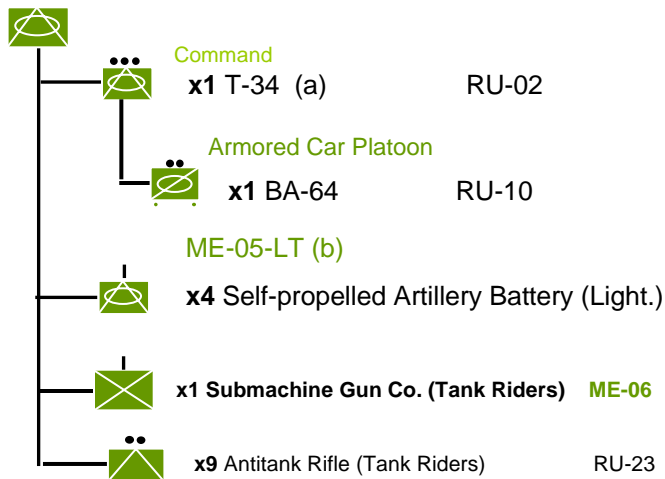

- (a) T-34, RU-02 for Light and Medium Regiments, KV-1, RU-04 for Heavy Regiments
- (b) Light Batteries, ME-05-LT for Light Regiments, Medium Batteries, ME-05-MED for Medium Regiments, and Heavy Batteries, ME-05-HVY for Heavy Regiments

Battle Group 29

Antiaircraft Regiment April 1943

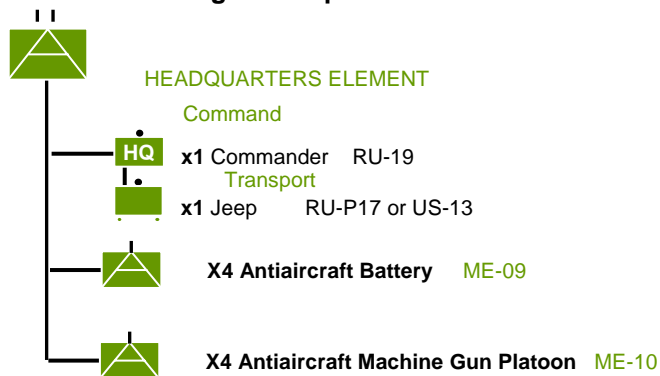

Battle Group 30

Antitank Regiment April 1943 – May 1945

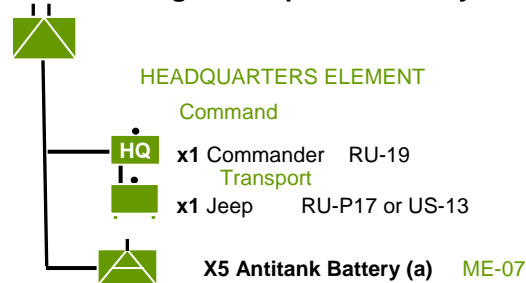

- (a) Reduce the number of guns in a Antitank Regiment Battery to 2 instead of 3.
- (b) Antitank Regiments were equipped with either 45mm, RU-13, 57mm, RU-14, or 76.2mm, RU-15 antitank guns after June 1943.
- (c) By April 1944 a 6th battery was added and the 45mm gun was removed from service.

Battle Group 29A

Tank Corp Antiaircraft Regiment June 1942

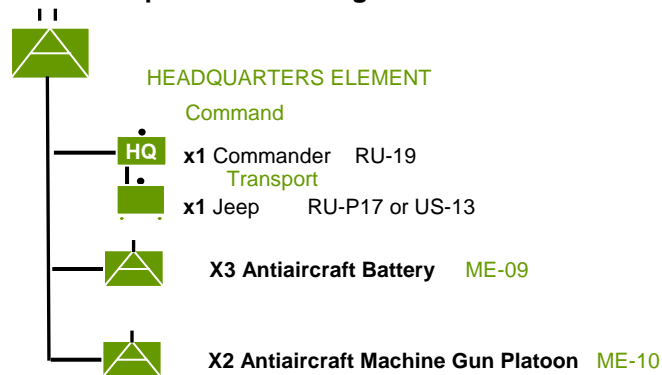

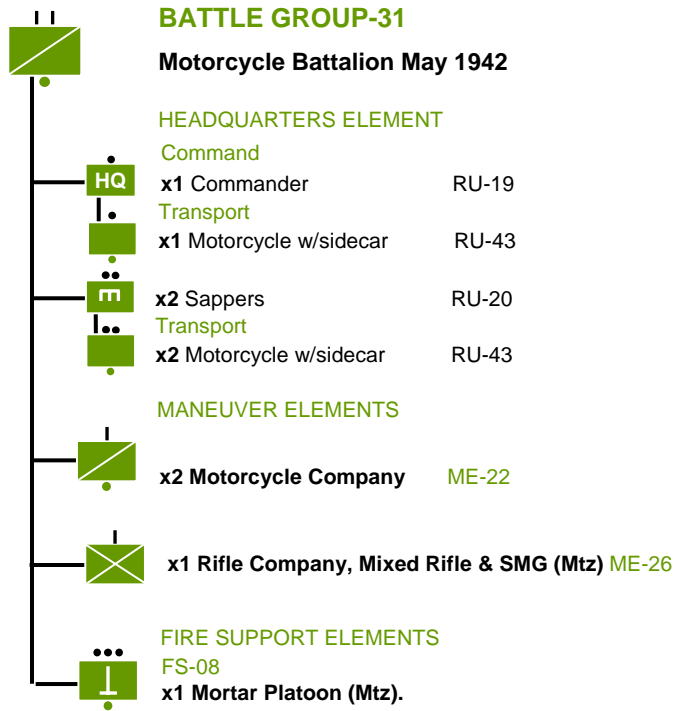

(a) In April 1943 replace ME-32 with ME-40

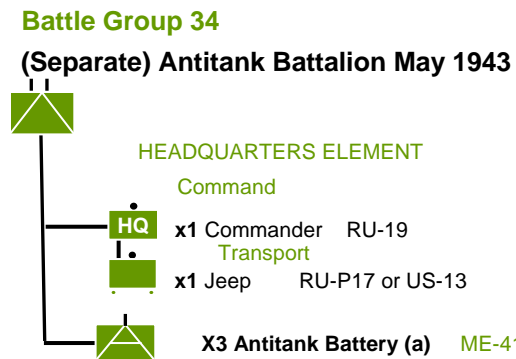
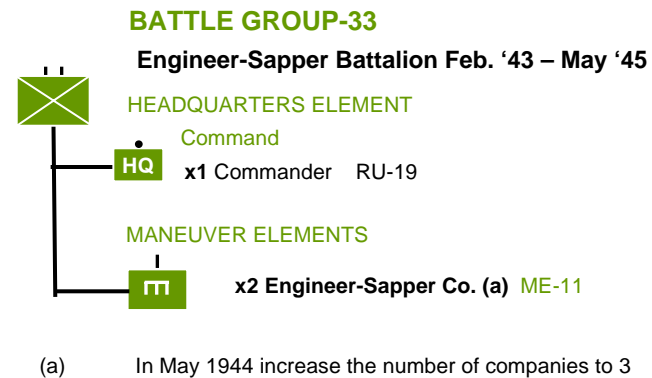

Battle Group-35

Heavy Tank Brigade March '42 – Oct '43

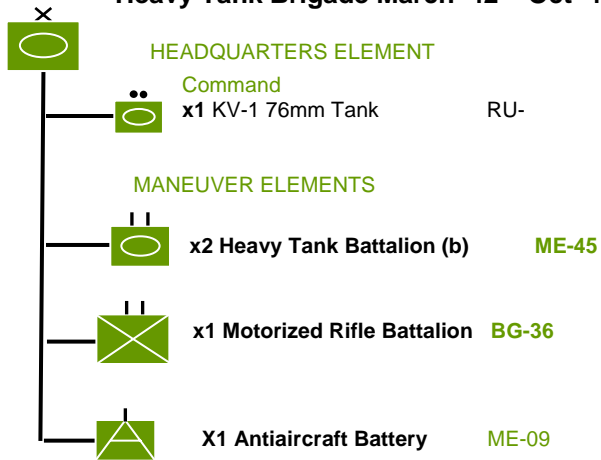

(a) In July 1942, add Armored Car Platoon and Antitank Battery

Battle Group-36

Motorized Rifle Battalion March 1942 – May 1945

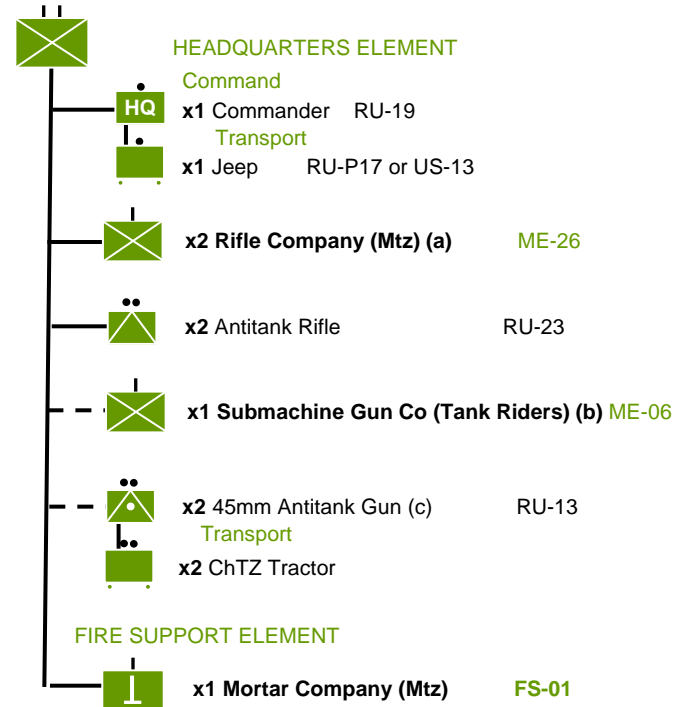

- (a) In April 1943 replace ME-26 with ME-04
- (b) In January 1943 add Submachine Gun Co.
- (c) In October 1943 add Antitank Guns

Battle Group-37

Tank Brigade March '42 – Oct '43

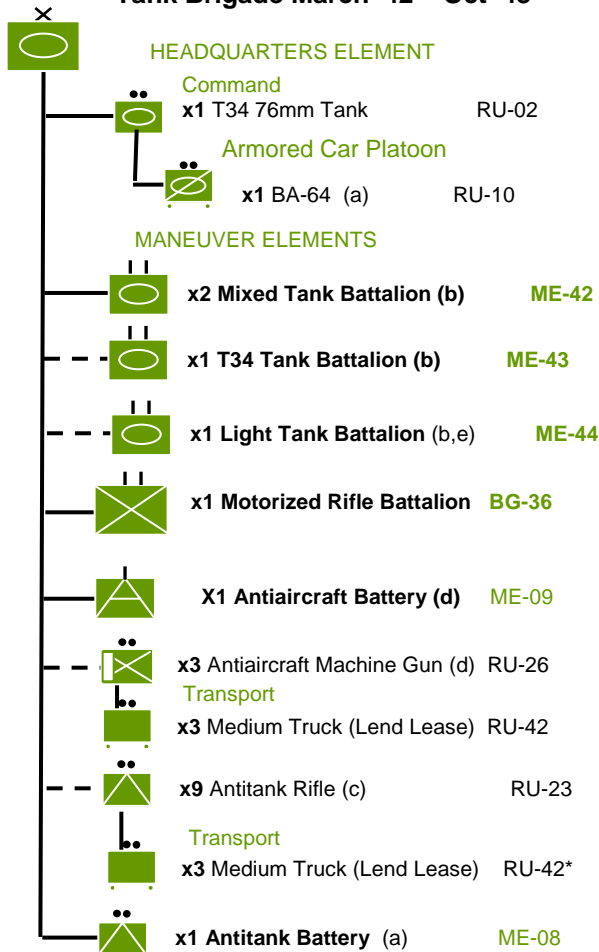

Battle Group-38

Tank Brigade Oct '43 – May '45

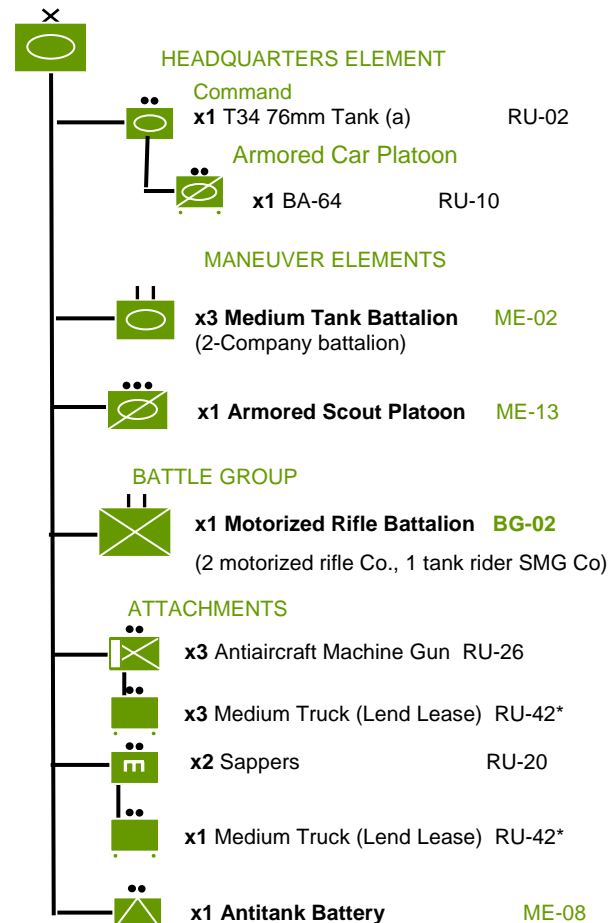

- (a) In July 1942, add Armored Car Platoon and Antitank Battery
- (b) In July replace Mixed Tank Battalions with T34 and Light Battalions
- (c) In January 1943 add Antitank Rifles
- (d) In April 1943 replace Antiaircraft Battery with Antiaircraft Machineguns
- (e) In April 1943, begin replacing light tanks with medium tanks.

- (a) In early 1944, may replace T34 76mm Tank with T34 85mm Tank, RU-03

Battle Group-39

Heavy Tank Regiment February 1944 – May 1945 or

Guards Heavy Tank Regiment Feb '44-May '45

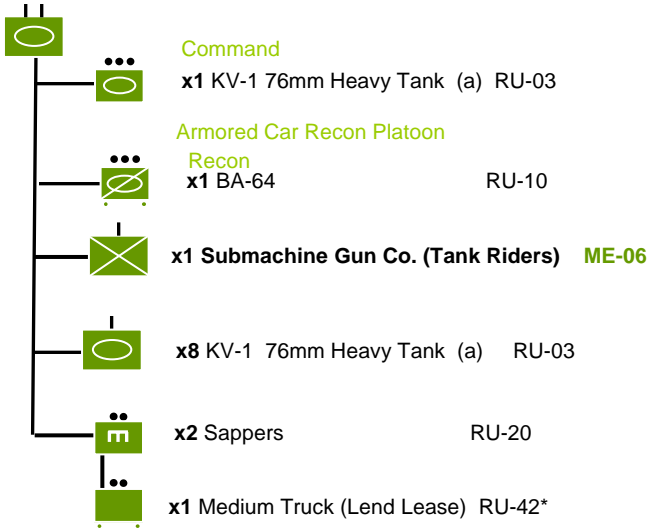

(a) May replace Kv-1 with:
 JS-II RU-04
 KV-85
 Churchill IV

Battle Group-40

Guards Heavy Tank Brigade November '44 – May '45

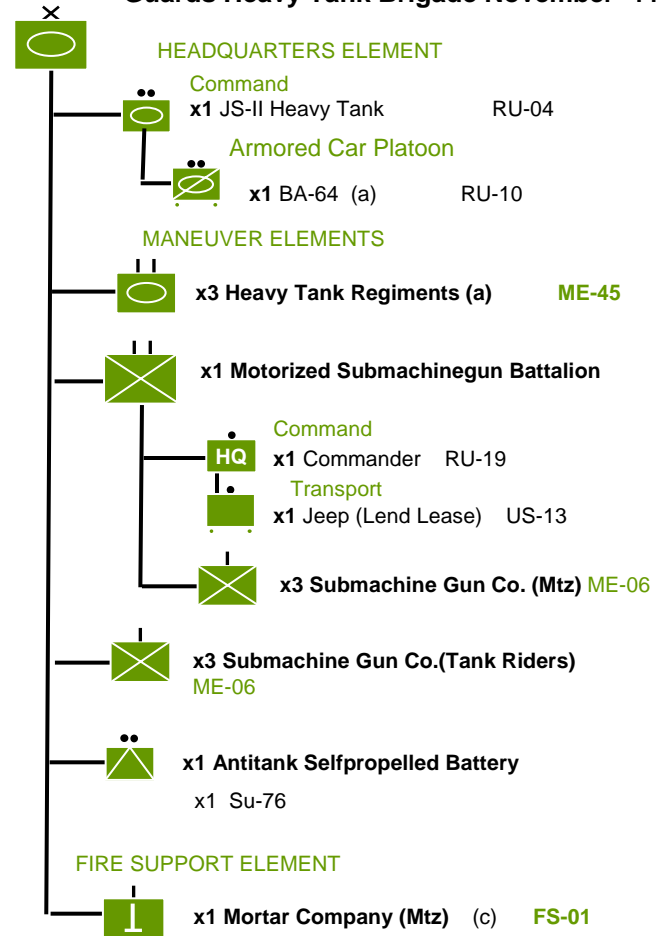

dhdg

Battle Group-41

Motorized Brigade March 1942 – May 1945

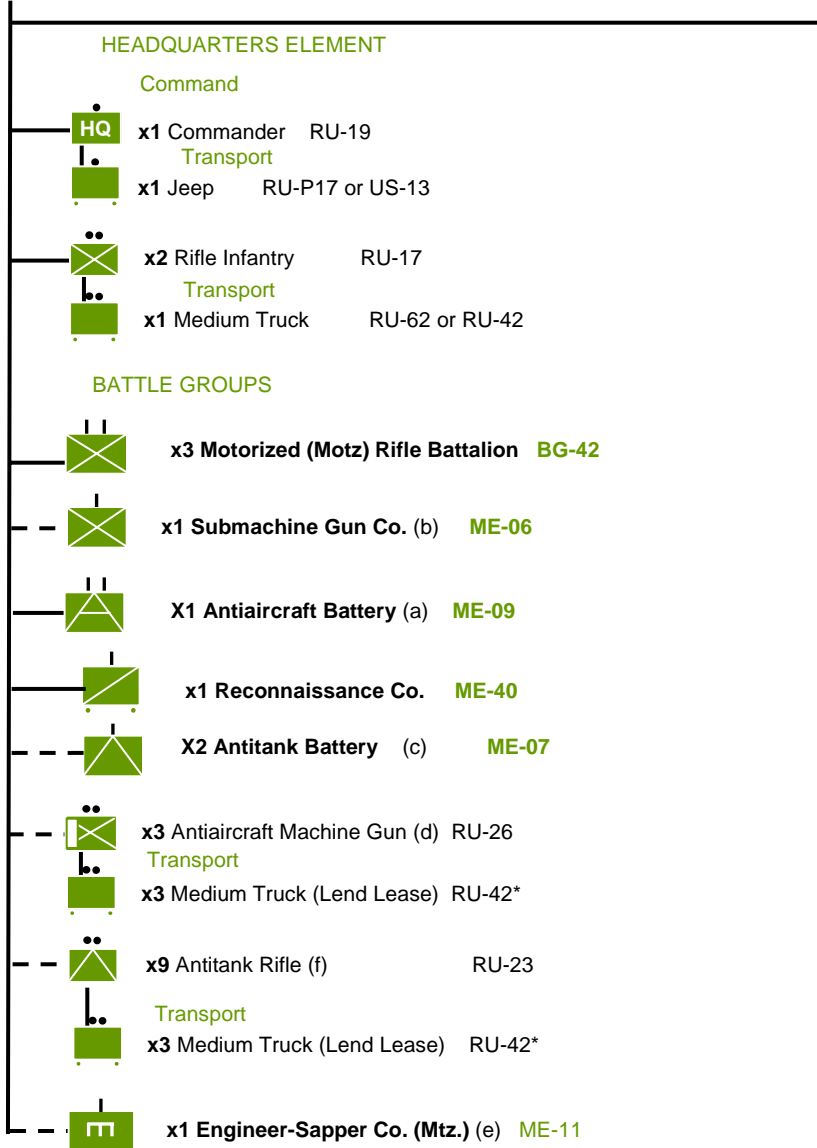

FIRE SUPPORT ELEMENTS

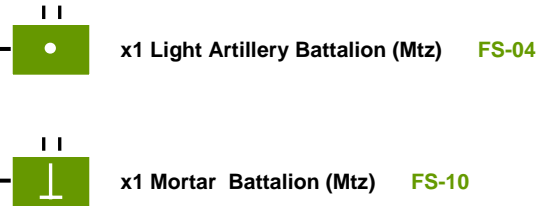

- (a) In December 1943, replace the Antiaircraft Battery with Antiaircraft Battalion BG-23
- (b) In December 1942 add Submachine Gun Company
- (c) In December 1942 add Antitank Company
- (d) In February 1943, add Antiaircraft Machinegun Company
- (e) In February 1943 add Engineer-Sapper Company.
- (f) In March 1943 add Antitank Rifles

Battle Group-42

Motorized (Motz) Rifle Battalion Sept 42 – May 1945

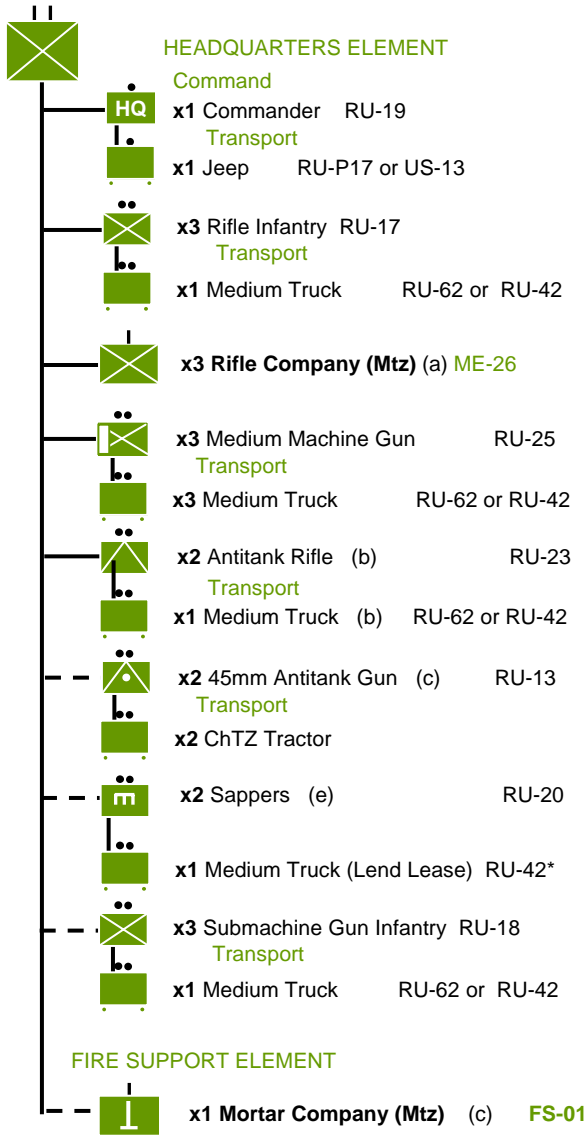

- (a) In December 1942 begin replacing ME-26 with ME-04
- (b) In December 1942 increase the number of ATR to 9 and the number of Transport to 4
- (c) In December 1942 add the Antitank Company, Mortar Company, Sapper Platoon, and Submachine Gun Platoon.

Maneuver Element - 40

Mechanized Recon Company Sept 42

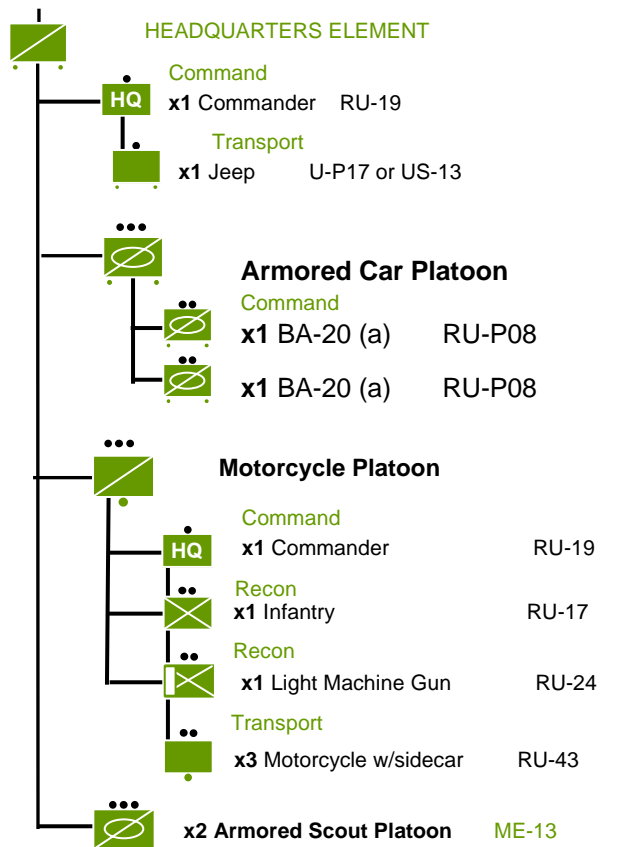

(a) May replace with BA-10 - RU-61 or BA-64B - RU-10

Maneuver Element- 41

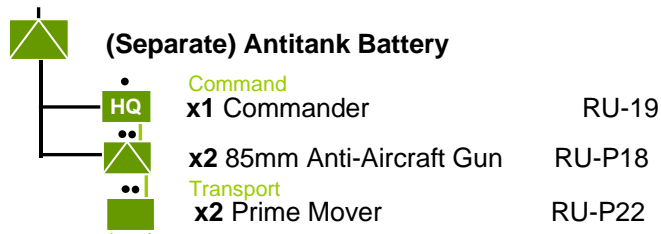

Maneuver Element- 05-LT

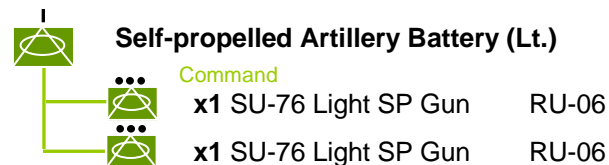

Maneuver Element- 05-MED

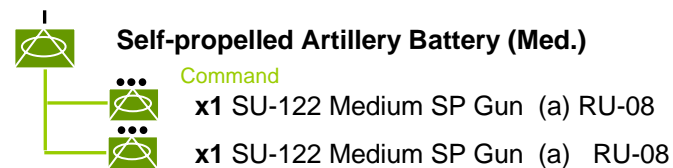

(a) After August 1942, replace with SU-85, RU-07

(b) After September 1944 replace all with SU-100, RU-31

Maneuver Element- 05-Hvy

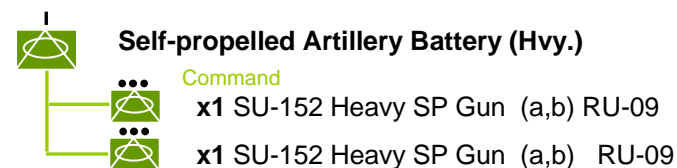

(a) In February 1944 replace SU-152 with ISU-122, RU-30

(b) Alternate Card is RU-P13

Maneuver Element - 42

Mixed Tank Battalion March '42



Maneuver Element - 43

T34 Tank Battalion July '42

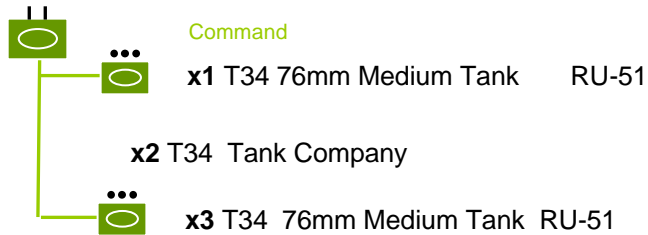

Maneuver Element - 44

Light Tank Battalion July '42

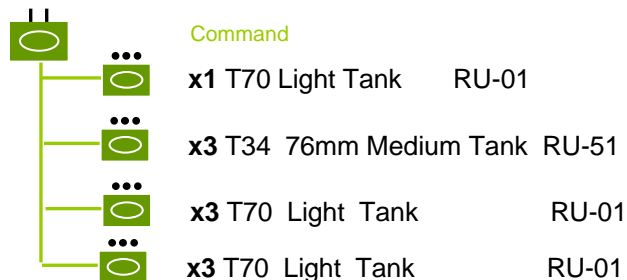

Maneuver Element - 45

Heavy Tank Regiment November 1944

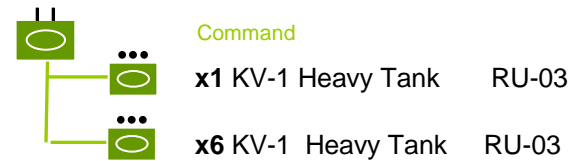

(a) May replace Kv-1 with:
 JS-II RU-04
 KV-85
 Churchill IV

Maneuver Element - 46

Guards Breakthrough Tank Regiment October 1942



(a) May replace Kv-1 with:
 JS-II RU-04
 KV-85
 Churchill IV

Fire Support Element-10

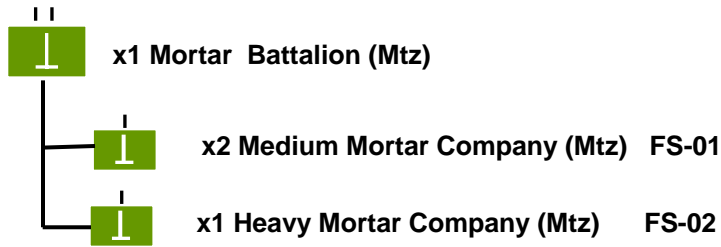

Fire Support Element-13

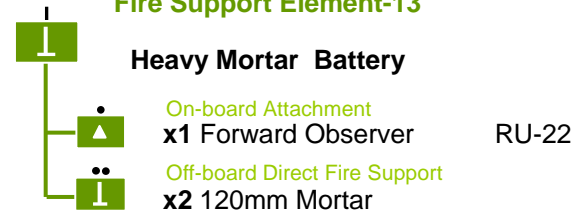

Fire Support Element-11

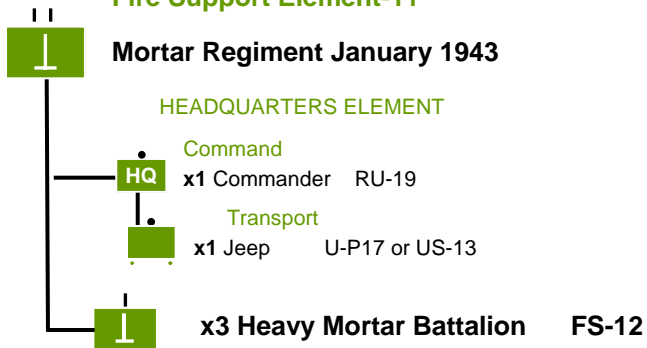

Fire Support Element-14

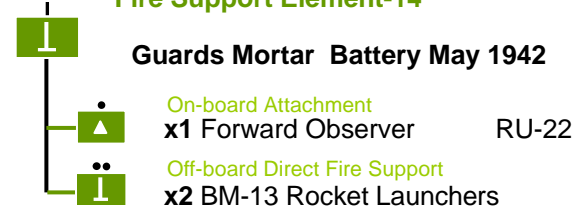

Fire Support Element-12

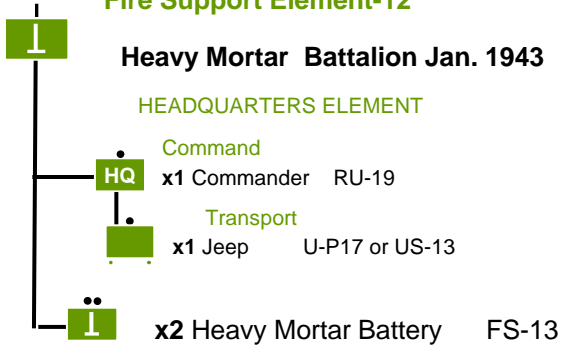

Fire Support Element-15

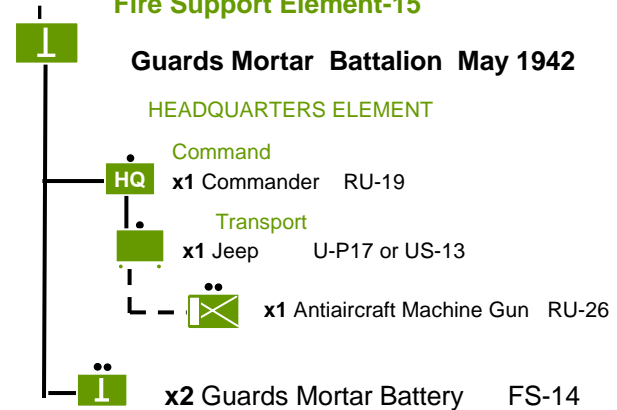

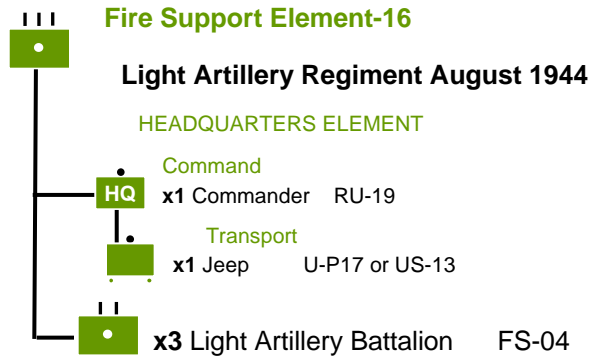

- (a) Light Artillery Battalion has only 2 batteries instead of 3 that are listed for FS-04